

TASCAM[®]
TEAC PROFESSIONAL

D01061020A

BB-1000CD

Portable CD/SD Recorder

OWNER'S MANUAL

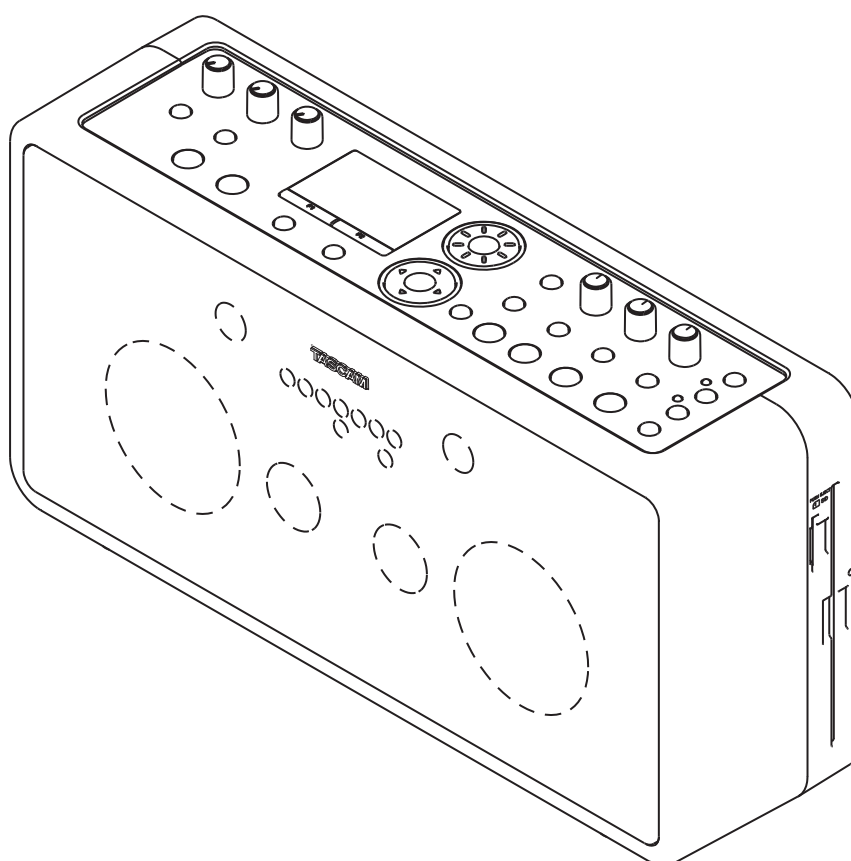

IMPORTANT SAFETY PRECAUTIONS



CAUTION
RISK OF ELECTRIC SHOCK
DO NOT OPEN



CAUTION: TO REDUCE THE RISK OF ELECTRIC SHOCK, DO NOT REMOVE COVER (OR BACK). NO USER-SERVICEABLE PARTS INSIDE. REFER SERVICING TO QUALIFIED SERVICE PERSONNEL.



The lightning flash with arrowhead symbol, within equilateral triangle, is intended to alert the user to the presence of uninsulated "dangerous voltage" within the product's enclosure that may be of sufficient magnitude to constitute a risk of electric shock to persons.



The exclamation point within an equilateral triangle is intended to alert the user to the presence of important operating and maintenance (servicing) instructions in the literature accompanying the appliance.

This appliance has a serial number located on the rear panel. Please record the model number and serial number and retain them for your records.

Model number _____

Serial number _____

WARNING: TO PREVENT FIRE OR SHOCK HAZARD, DO NOT EXPOSE THIS APPLIANCE TO RAIN OR MOISTURE.

For U.S.A.

TO THE USER

This equipment has been tested and found to comply with the limits for a Class B digital device, pursuant to Part 15 of the FCC Rules. These limits are designed to provide reasonable protection against harmful interference in a residential installation. This equipment generates, uses, and can radiate radio frequency energy and, if not installed and used in accordance with the instruction manual, may cause harmful interference to radio communications. However, there is no guarantee that interference will not occur in a particular installation. If this equipment does cause harmful interference to radio or television reception, which can be determined by turning the equipment off and on, the user is encouraged to try to correct the interference by one or more of the following measures.

- a) Reorient or relocate the receiving antenna.
- b) Increase the separation between the equipment and receiver.
- c) Connect the equipment into an outlet on a circuit different from that to which the receiver is connected.
- d) Consult the dealer or an experienced radio/TV technician for help.

CAUTION

Changes or modifications to this equipment not expressly approved by TEAC CORPORATION for compliance could void the user's authority to operate this equipment.

IMPORTANT SAFETY INSTRUCTIONS

- 1 Read these instructions.
- 2 Keep these instructions.
- 3 Heed all warnings.
- 4 Follow all instructions.
- 5 Do not use this apparatus near water.
- 6 Clean only with dry cloth.
- 7 Do not block any ventilation openings. Install in accordance with the manufacturer's instructions.
- 8 Do not install near any heat sources such as radiators, heat registers, stoves, or other apparatus (including amplifiers) that produce heat.
- 9 Do not defeat the safety purpose of the polarized or grounding-type plug. A polarized plug has two blades with one wider than the other. A grounding type plug has two blades and a third grounding prong. The wide blade or the third prong are provided for your safety. If the provided plug does not fit into your outlet, consult an electrician for replacement of the obsolete outlet.
- 10 Protect the power cord from being walked on or pinched particularly at plugs, convenience receptacles, and the point where they exit from the apparatus.
- 11 Only use attachments/accessories specified by the manufacturer.
- 12 Use only with the cart, stand, tripod, bracket, or table specified by the manufacturer, or sold with the apparatus. When a cart is used, use caution when moving the cart/apparatus combination to avoid injury from tip-over.
- 13 Unplug this apparatus during lightning storms or when unused for long periods of time.
- 14 Refer all servicing to qualified service personnel. Servicing is required when the apparatus has been damaged in any way, such as power-supply cord or plug is damaged, liquid has been spilled or objects have fallen into the apparatus, the apparatus has been exposed to rain or moisture, does not operate normally, or has been dropped.
 - Do not expose this apparatus to drips or splashes.
 - Do not place any objects filled with liquids, such as vases, on the apparatus.
 - Do not install this apparatus in a confined space such as a book case or similar unit.
 - The apparatus draws nominal non-operating power from the AC outlet with its POWER or STANDBY/ON switch not in the ON position.
 - The apparatus should be located close enough to the AC outlet so that you can easily grasp the power cord plug at any time.
 - The main plug is used as the disconnect device, the disconnect device shall remain readily operable.
 - An apparatus with Class I construction shall be connected to an AC outlet with a protective grounding connection.
 - Batteries (battery pack or batteries installed) should not be exposed to excessive heat such as sunshine, fire or the like.
 - Excessive sound pressure from earphones and headphones can cause hearing loss.



- 13 Unplug this apparatus during lightning storms or when unused for long periods of time.

IMPORTANT SAFETY PRECAUTIONS

Cautions about Batteries

This product uses batteries. Misuse of batteries could cause a leak, rupture or other trouble. Always abide by the following precautions when using batteries.

- Never recharge non-rechargeable batteries. The batteries could rupture or leak, causing fire or injury.
- When installing batteries, pay attention to the polarity indications (plus/minus (+/-) orientation), and install them correctly in the battery compartment as indicated. Putting them in backward could make the batteries rupture or leak, causing fire, injury or stains around them.
- When throwing used batteries away, follow the disposal instructions indicated on the batteries and the local disposal laws. When you store or dispose batteries, isolate their terminals with insulation tape or something like that to prevent them from contacting other batteries or metallic objects.
- Do not use batteries other than those specified. Do not mix and use new and old batteries or different types of batteries together. The batteries could rupture or leak, causing fire, injury or stains around them.
- Do not carry or store batteries together with small metal objects. The batteries could short, causing leak, rupture or other trouble.
- Do not heat or disassemble batteries. Do not put them in fire or water. Batteries could rupture or leak, causing fire, injury or stains around them.
- If the battery fluid leaks, wipe away any fluid on the battery case before inserting new batteries. If the battery fluid gets in an eye, it could cause loss of eyesight. If fluid does enter an eye, wash it out thoroughly with clean water without rubbing the eye and then consult a doctor immediately. If the fluid gets on a person's body or clothing, it could cause skin injuries or burns. If this should happen, wash it off with clean water and then consult a doctor immediately.
- The unit power should be off when you install and replace batteries.
- Remove the batteries if you do not plan to use the unit for a long time. Batteries could rupture or leak, causing fire, injury or stains around them. If the battery fluid leaks, wipe away any fluid on the battery compartment before inserting new batteries.
- Small children may mistakenly swallow a lithium coin battery and it is very dangerous. Keep the battery and the remote control out of the reach of small children. In the event a battery is swallowed, immediately consult a physician.

IMPORTANT SAFETY PRECAUTIONS

This product has been designed and manufactured according to FDA regulations “title 21, CFR, chapter 1, subchapter J, based on the Radiation Control for Health and Safety Act of 1968”, and is classified as a class 1 laser product. There is no hazardous invisible laser radiation during operation because invisible laser radiation emitted inside of this product is completely confined in the protective housings.

The label required in this regulation is shown at ①.

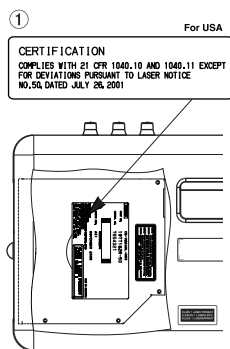

CAUTION

- **DO NOT REMOVE THE PROTECTIVE HOUSING USING A SCREWDRIVER.**
- **USE OF CONTROLS OR ADJUSTMENTS OR PERFORMANCE OF PROCEDURES OTHER THAN THOSE SPECIFIED HEREIN MAY RESULT IN HAZARDOUS RADIATION EXPOSURE.**
- **IF THIS PRODUCT DEVELOPS TROUBLE, CONTACT YOUR NEAREST QUALIFIED SERVICE PERSONNEL, AND DO NOT USE THE PRODUCT IN ITS DAMAGED STATE.**
- **CLASS 1M INVISIBLE LASER RADIATION WHEN OPEN AND INTERLOCKS DEFEATED. DO NOT VIEW DIRECTLY WITH OPTICAL INSTRUMENTS.**

Optical pickup

Type : HOP-6201TC
 Manufacturer : Hitachi Media Electronics Co.,Ltd.
 Laser output : Less than 75 mW on the objective lens (record)
 Wavelength : 777 to 787 nm

产品有毒有害物质或元素的名称及含量

机种：BB-1000CD		有毒有害物质或元素					
	品名	铅 (Pb)	汞 (Hg)	镉 (Cd)	六价铬 (Cr(VI))	多溴联苯 (PBB)	多溴二苯醚 (PBDE)
1	CHASSIS 部份	○	○	○	○	○	○
2	PCB Assy 部份	×	○	○	○	○	○
3	线材部份	○	○	○	○	○	○
4	附属品部份	×	○	○	○	○	○
7	SEAL 部份	○	○	○	○	○	○
8	包装部份	○	○	○	○	○	○

○：表示该有毒有害物质在该部件所有均质材料中的含有量均在 SJ/T11363-2006 标准规定的限量要求以下。
 ×：表示该有毒有害物质至少在该部件的某一均质材料中的含量超出 SJ/T11363-2006 标准规定的限量要求。
 (针对现在代替技术困难的电子部品及合金中的铅)

What you can do with the unit

Playback

Listening to a disc

When playing back a disc, insert it and press the **CD** key.

You can use the unit when...

- listening to a commercially available audio CD.
- listening to a disc on which you recorded.

☞ page 19 “Playing back a disc (commercially available audio CD)”
page 36 “Playback”

Listening to files on an SD card

When playing back an audio file on an SD card, insert it and press the **SD** key.

You can use the unit when...

- playing back an SD card containing WAV files and MP3 files.
- playing back an SD card on which you recorded.

☞ page 30 “Inserting an SD card”
page 36 “Playback”

What types of files can this unit play back?

MP3 files and WAV files on an SD card can be played back.

☞ page 36 “Playable file format”

To select files to play back on an SD card

The unit plays only files in a folder which contains the currently playing file when you are using an SD card. You can select a folder to playback on an SD card on the **BROWSE** screen.

☞ page 48 “Browsing an SD card”

What you can do with the unit

Recording

Difference between a disc and SD card

Same as a commercially available audio CD, sound is recorded on a disc in the CD-DA format. The disc can be played back on a standard CD player.

You can record sound on an SD card on the WAV or MP3 format. You can record for a longer period of time by using the MP3 format though the sound quality is inferior to a CD's.

In addition, you can edit audio files on the SD card such as dividing them.

Recording on a disc

☞ page 38 “Recording”

What disc is recordable?

You can use a CD-R or CD-RW for recording.

☞ page 17 “About CD-R and CD-RW discs”

What is finalization?

To playback a disc recorded on the unit on another device, the process called finalization is required. You cannot record on a CD-R disc any more after finalization. You can make a finalized CD-RW disc recordable again by unfinalizing it.

☞ page 47 “Finalizing a disc”

page 47 “Unfinalizing a CD-RW”

Recording on an SD card

☞ page 38 “Recording”

To record in higher sound quality

You can record in the same sound quality as that of a commercially available CD.

It is useful when...

- recording a live performance, concert or recital.

☞ page 45 “Long time recording”

To record for a longer period of time

You can record longer in less file size by using the MP3 format.

It is useful when...

- recording for many hours in a conference or event.

☞ page 45 “Long time recording”

What you can do with the unit

Recording with the built-in microphones

To record sounds all around the unit by using the front and rear microphones

You can record sounds around the unit by using the built-in microphones on the front and rear. It is suitable when recording the music played in a circle, placing the unit at the center of the circle. Select **FRNT/REAR** at **SOURCE** in the **INPUT** screen to record sound using the front and rear microphones.

It is useful when...

- recording sound of a small orchestra surrounding the unit.
- recording sound of a band in a sound room placing the unit at its center.
- recording a meeting.

☞ page 38 “Selecting the input”

To record sound using the front microphones only

It is suitable when recording a small band or solo play. Select **FRNT/REAR** at **SOURCE** in the **INPUT** screen and turn the **REAR MIC** knob down to the minimum to record by the front microphones only.

It is useful when...

- sound source exists in front of the unit only, such as in a private lesson or solo play.
- recording sound of a big orchestra at a position such as the conductor's.

☞ page 38 “Selecting the input”

Recording with external microphones

When using external microphones, connect them to the **EXT MIC** jacks on the left side and select **EXT/REAR** at **SOURCE** in the **INPUT** screen. Turn the **REAR MIC** knob down to the minimum. Slide the **PHANTOM** switch to **ON** when using condenser microphones in addition.

It is useful when...

- recording in high quality with using high-performance condenser microphones.

☞ page 35 “Connecting to the EXT MIC jacks”

page 38 “Selecting the input”

Recording the sound from an external device

To record the sound of a tape recorder or record player

You can record the playback sound of an external device such as a tape recorder or record player. Connect a device to the **LINE IN** jack on the left side and select **FRNT/LINE** at **SOURCE** in the **INPUT** screen. Turn the **FRONT MIC** knob down to the minimum.

You can give numbers to tracks automatically by using the auto recording function (page 44).

It is useful when...

- copying sound on a cassette tape or MD on to a CD or SD card.
- recording sound on media unplayable on this unit.
- recording sound through the line output of an electric instrument.

☞ page 35 “Connecting to the LINE IN jack”

page 38 “Selecting the input”

What you can do with the unit

Settings for flexible recording

Adjusting recording level automatically

The recorded sound may distort when the input level is too high and it may become noisy when the level is too low. The level control functions on the unit adjust the input level automatically according to the strength of input signals to get appropriate volume.

It is useful when...

- some speakers speak loudly and others low in a meeting or conference.
- a loud sound comes out suddenly such as in a live performance.

☞ page 38 “Adjusting the input settings”

Adjusting recording level manually

Automatic adjustment of input level by the level control functions may result in a little bit unnatural sound volume. It is recommended to adjust the recording level manually to get better sound.

☞ page 39 “Ordinary recording”

Starting recording automatically

You can start recording automatically as sound comes in from microphones by using the automatic recording function.

It is useful when...

- starting recording as sound comes out in a event or conference.

☞ page 44 “Auto recording”

Skipping silence while recording

You can set the unit to pause recording automatically when no sound comes in from microphones by using the automatic recording function.

It is useful when...

- you do not want to record silence in a meeting.

☞ page 44 “Auto recording”

Dividing recording files automatically

You can set the unit to make a new recording file as it detect silence for a certain moment by using the automatic recording function.

It is useful when...

- dividing recording files as presenters change in a conference.
- dividing files per tracks without stopping playback during recording sound from a cassette tape or record.

☞ page 44 “Auto recording”

What you can do with the unit

Assisting practice of an instrument

Tuning of an instrument

You can use the unit as a chromatic tuner or oscillator.

☞ page 41 “Using the Tuner”

Practicing with the metronome

You can use the unit as a metronome.

☞ page 41 “Using the Metronome”

Changing the playback speed

You can change the playback speed of a CD or SD card without changing the key.

It is useful when...

- practicing in slow speed at first and gradually increasing the speed.
- copying a quick musical phrase.

☞ page 42 “Changing the playback speed”

Changing the playback key

You can change the playback key without changing the playback speed.

It is useful when...

- practicing in a higher or lower key.

☞ page 42 “Changing the playback key”

playing back a certain part of a song repeatedly

You can specify a section and play back it repeatedly.

It is useful when...

- practicing a new phrase repeatedly.
- listening to a difficult phrase repeatedly.

☞ page 37 “Loop playback (I-O LOOP)”

Skipping a track a little backward

You can skip back a few second while playing back a track by pressing the **FLASHBACK** key. The skip back time is adjustable (1-5 seconds).

It is useful when...

- missing an important phrase.

☞ page 36 “Skipping a track a little backward (FLASH BACK)”

page 50 “Adjusting the time of FLASH BACK”

What you can do with the unit

Reducing the volume of a certain part

You can select a certain position and reduce the sound volume from the position.

It is useful when...

- practicing a song reducing the vocal sound on a CD.
- practicing a certain instrument in an orchestra by reducing the part on a CD.

☞ page 42 “Reducing sound of a certain location (PART CANCEL)”

Overdubbing on a playback sound

You can mix up the playback sound of a disc or SD card and that from microphones and the **LINE IN** jack and record the mixed sound on to an SD card,

Easy overdubbing

You can mix up sound casually with the playback sound from speakers. Both the playback sound and your sound are recorded through microphone.

It is useful when...

- overdubbing the play of two or more people on the playback sound.
- overdubbing sound of an acoustic instrument such as strings or horn.

☞ page 39 “Mixing up the playback sound and your play (OVERDUB)”

Recording sound in high quality

Overdub a new sound monitoring the playback sound with headphones. The playback sound is recorded directly as digital signals and you can record sound in high quality.

It is useful when...

- overdubbing the sound of instruments which need line input such as an electric guitar.

☞ page 40 “Overdubbing in higher sound quality (DIRECT MIX)”

Editing an audio file

You can edit files on an SD card only. You cannot edit tracks on a disc.

Dividing a file

You can divide a WAV file recorded on an SD card into two or more files. You cannot divide an MP3 file.

It is useful when...

- deleting silent parts of an audio file.
- dividing a long recording file of a meeting at certain points.
- dividing a file recording a whole concert song by song.

☞ page 46 “Editing a file”

What you can do with the unit

Changing the playback order of files

You can change the playback order of audio files on an SD card.

It is useful when...

- changing the order as you like.
- changing the order following your practice order.

☞ page 46 “Editing a file”

Deleting files

You can delete unnecessary audio files on an SD card.

☞ page 46 “Editing a file”

Copying music files

Copying tracks on a disc on to an SD card

You can copy selected tracks on a disc on to an SD card. You can save file size by using the MP3 format when copying.

It is useful when...

- copying only your favorite tracks from discs.

☞ page 43 “Copying a CD onto an SD card”

Copying files on an SD card on to a disc

You can copy music files on an SD card on to a disc. You can arrange the order of the selected files when copying. You can play the disc on standard CD players.

It is useful when...

- copying and distributing discs containing a playing sample to your students for their practice.

☞ page 43 “Writing files on an SD card onto a disc”

Backing up a disc

You can make a backup of a disc by copying its whole contents on to an SD card and copy them on a blank disc.

☞ page 44 “Duplicating an audio CD”

Other useful functions

Making a CD-RW recordable again

You can remove finalization on a finalized CD-RW for additional recording.

☞ page 47 “Unfinalizing a CD-RW”

Formatting an SD card

When using a new SD card or one used on another device on the unit, it is recommended to format the card before starting to use it. The possibility of recording error may become higher when using an SD card formatted on another device.

All the folders and files recorded on an SD card are erased by formatting.

☞ page 49 “Formatting an SD card”

IMPORTANT SAFETY PRECAUTIONS	2	6–Connection	35
What you can do with the unit.....	6	Connecting monitors.....	35
1–Introduction.....	15	Connecting external microphones and an audio device.....	35
Main features	15	Connecting to the EXT MIC jacks.....	35
Included items.....	15	Connecting to the LINE IN jack.....	35
Note about this manual.....	15	7–Playback	36
Trademarks, copyrights, and disclaimers	15	Playable file format.....	36
Cautions on installation	16	Playback	36
Beware of condensation.....	16	Skipping a track a little backward (FLASH BACK)	36
Cleaning the unit.....	16	Playback from marked points.....	36
About SD cards	16	Repeat playback	37
Precautions for use	16	Loop playback (L–O LOOP)	37
About Discs.....	16	Adjusting the volume	37
Cautions.....	16	8–Recording	38
About CD-R and CD-RW discs	17	Recording environment.....	38
Inserting a disc into the slot-loading drive.....	17	Selecting the input	38
2–Quick start guide.....	18	Adjusting the input settings.....	38
Preparation	18	Volume balance adjustment	38
Turning the power on and off.....	18	Adjusting the balance of microphones	38
Playing back a disc (commercially available audio CD)	19	Adjusting the level of playback signal	38
Loading a disc	19	Ordinary recording	39
Selecting the playback media.....	19	Overdubbing	39
Playing back.....	19	Preparation for overdubbing	39
Adjusting the volume	19	Overdub recording.....	40
Using the special playback control functions (changing pitch and speed of playback).....	19	Overdubbing in higher sound quality (DIRECT MIX)	40
Recording.....	20	9–For practicing musical instruments.....	41
Inserting an SD card	20	Using the Tuner	41
Recording on an SD card	20	Preparation.....	41
Recording on a disc.....	21	Chromatic tuner mode.....	41
3–Part Names and Functions.....	23	Oscillator mode.....	41
Top panel	23	Using the Metronome	41
Front Panel.....	25	Setting the metronome.....	41
Rear Panel	25	Starting and stopping the metronome.....	42
Left side panel.....	26	Practicing with CD/SD playback	42
Right side panel	27	Changing the playback key.....	42
Remote control unit (RC-BB1000).....	27	Changing the playback speed.....	42
4–Preparation.....	28	Reducing sound of a certain location (PART CANCEL).....	42
Powering the unit	28	Practicing a certain phrase repeatedly.....	42
Connecting the AC adapter.....	28	Recording the practice with CD/SD.....	42
Installing the batteries	28	10–Other useful functions.....	43
Remote control unit	28	Copying audio files	43
Installing the battery.....	28	Copying a CD on to an SD card	43
Battery replacement.....	28	Writing files on an SD card onto a disc.....	43
Precautions concerning batteries.....	29	Duplicating an audio CD	44
Precautions using remote control unit	29	Changing recording settings	44
Turning the power on and off.....	29	Auto recording.....	44
Setting the date and time	29	Long time recording	45
Inserting an SD card	30	About the recording time	45
Removing the SD card.....	30	Editing a file	46
When using a new SD card	30	11–Managing recording media	47
Write protection	30	Finalizing a disc.....	47
Loading a disc.....	30	Unfinalizing a CD-RW.....	47
Ejecting a disc.....	31	Deleting tracks on a CD-RW	47
Selecting the recording/playback media.....	31	Browsing an SD card.....	48
5–Screen Overview.....	32	Screen navigation.....	48
Home screen	32	Icons on the BROWSE screen.....	48
Record screen.....	33	File operations.....	48
Setting screens.....	33	Folder operations.....	49
Setting screen structure.....	33	Formatting an SD card.....	49
Operation basics	33		
Operation example.....	34		
Setting screen list.....	34		

Contents

12–Environmental settings	50
Backlight Auto OFF setting	50
Adjust the display contrast	50
Adjusting the time of FLASH BACK	50
Setting the date and time	50
13–Messages	51
14–Troubleshooting	53
15–Specifications	54
Specifications	54
CD recorder	54
Audio input and output	54
Audio performance	54
General	54
Dimensions	55

Thank you very much for purchasing the TASCAM BB-1000CD Portable CD/SD Recorder. Please read this Owner's Manual carefully in order to maximize your use of all the unit's features. We hope that you will enjoy using this recorder for many years to come. After you have finished reading this manual, keep it in a safe place.

Main features

- Boom box style Portable CD/SD Recorder
- Directly recording to CD-R/RW and SD (SDHC)
CD: CD-DA (16-bit / 44.1 kHz)
SD: WAV (16-bit / 44.1 kHz), MP3 (High (192 kbps), Mid (128 kbps), Low (64 kbps) / 44.1 kHz)
- Copy from SD(WAV, MP3) to CD (CD-DA) / CD (CD-DA) to SD (WAV, MP3)
- VSA (Variable Speed Audition) changes playback speed without pitch change, and changes pitch without speed change
- Easy operation with dedicated knobs and keys
- 5 W + 5 W digital amplifier (Class D Delta-Sigma modulation with 512 times over-sampling by 1-bit amplifier technology)
- Two pairs of stereo microphones on the front and rear for 360-degree recording for band recording and minutes recording
- Over-dub recording
- Powered through 8 x AA batteries or AC power adapter
- Wireless remote control unit
- 2 x XLR mic inputs with +48 V phantom power

Included items

The included items are listed below.

Take care when opening the package not to damage the items. Keep the package materials for transportation in the future.

Please contact the store where you purchased this unit if any of these items are missing or have been damaged during transportation.

- | | |
|---------------------------------|---|
| • Main unit | 1 |
| • AC adapter [PS-1225L] | 1 |
| • Remote control [RC-BB1000] | 1 |
| • Lithium coin battery [CR2025] | 1 |
| • Warranty card | 1 |
| • Owner's manual (this manual) | 1 |

CAUTION

Be sure to use the supplied PS-1225L AC adapter and power cable. Also, do not use the supplied AC adapter and power cable with other devices. It may cause malfunctions, the fire and electric shock.

Note about this manual

Descriptions as below will be used on this manual.

- Keys and terminals on the unit and external devices and messages on the displays are written like this: **MENU**.
- The CD-DA format may also be mentioned as "audio CD" format. In addition, discs on which tracks are recorded in the audio CD format may be mentioned as an "audio CD".
- Additional information is introduced in the styles below when needed:

TIP

Useful hints when using the unit.

NOTE

Explanation of actions in special situation and supplement.

CAUTION

Instructions that should be followed to avoid injury, damage to the unit or other equipment, and loss of recording data.

Trademarks, copyrights, and disclaimers

SDHC Logo is a trademark.



MPEG Layer-3 audio coding technology licensed from Fraunhofer IIS and Thomson.

Supply of this product does not convey a license nor imply any right to distribute MPEG Layer-3 compliant content created with this product in revenue-generating broadcast systems (terrestrial, satellite, cable and/or other distribution channels), streaming applications (via Internet, intranets and/or other networks), other content distribution systems (pay-audio or audio-on-demand applications and the like) or on physical media (compact discs, digital versatile discs, semiconductor chips, hard drives, memory cards and the like). An independent license for such use is required. For details, please visit <http://mp3licensing.com>.

Other company names, product names and logos in this document are the trademarks or registered trademarks of their respective owners.

1-Introduction

Note

Any data, including, but not limited to information, described herein are intended only as illustrations of such data and/or information and not as the specifications for such data and/or information. TEAC CORPORATION disclaims any warranty that any use of such data and/or information shall be free from infringement of any third party's intellectual property rights or other proprietary rights, and further, assumes no liability of whatsoever nature in the event of any such infringement, or arising from or connected with or related to the use of such data and/or information.

This product is designed to help you record and reproduce sound works to which you own the copyright, or where you have obtained permission from the copyright holder or the rightful licensor. Unless you own the copyright, or have obtained the appropriate permission from the copyright holder or the rightful licensor, your unauthorized recording, reproduction or distribution thereof may result in severe criminal penalties under copyright laws and international copyright treaties. If you are uncertain about your rights, contact your legal advisor. Under no circumstances will TEAC Corporation be responsible for the consequences of any illegal copying performed using the recorder.

Cautions on installation

- The nominal operating temperature should be between 5°C and 35°C.
- Do not install in places as below. It may deteriorate sound quality and/or cause malfunctions:
 - a place susceptible to vibration or unstable
 - a place exposed to direct sunlight, such as by a window
 - a place excessively hot such as by a heater
 - a place excessively cold
 - a place with bad ventilation or excessively damp
- Hum noise may be generated when using the unit near a device which has a large transformer such as a power amplifier. Take a distance from such devices and turn the unit around to stop the noise.
- Using the unit near a TV or radio may cause picture deterioration or noise. Take a distance from such devices.

- Using wireless applications such as a cellular phone near the unit may cause noise, especially at incoming and outgoing of a call and during speaking over the phone. Take a distance from such devices or turning them off.
- Do not use the unit with the front panel down or side panels down. It may cause malfunctions of CD recording and playback. Install it with the operation panel up.

Beware of condensation

If the unit is moved from a cold to a warm place, or used after a sudden temperature change, there is a danger of condensation; vapor in the air could condense on the internal mechanism, making correct operation impossible. To prevent this, or if this occurs, let the recorder sit for one or two hours at the new room temperature before using.

Cleaning the unit

To clean the unit, wipe gently with a soft dry cloth. Do not use any benzene, paint thinner, ethyl alcohol or other chemical agents to clean the unit as they could damage the surface.

About SD cards

This unit uses SD cards for recording and playback. You can use 64 MB - 2 GB SD cards and 4 GB - 32 GB SDHC cards with this unit. A list of SD cards that have been tested with this unit can be found on the TASCAM web site (www.tascam.com).

Precautions for use

- SD cards are delicate media. In order to avoid damaging a card or the card slot, please take the following precautions when handling them.
- Do not leave them in extremely hot or cold places.
- Do not leave them in extremely humid places.
- Do not let them get wet.
- Do not put things on top of them or twist them.
- Do not hit them.

About Discs

The built-in CD drive on this unit can record/play back CD in the CD-DA format.

Cautions

- Please use CD, CD-R and CD-RW discs bearing the following logos.

CD-R



CD-RW



- Always insert the disc into the slot with the label side toward you. (Compact discs can be played or recorded only on one side.)
- To remove a disc from its storage case, press down on the center of the case and lift the disc out, holding it carefully by the edges.
- Avoid getting fingerprints on the signal side (the non-label side). Grime and dust may cause skipping.
- Should the disc become dirty, wipe the surface radially (from the center hole outward towards the outer edge) with a soft, dry cloth:
- Discs should be returned to their cases after use to avoid dust and scratches that could cause the laser pickup to “skip.”
- Never use such chemicals as record sprays, antistatic sprays or fluid, benzine or thinner to clean the discs. Such chemicals will do irreparable damage to the disc’s plastic surface.
- Do not affix any labels or stickers to the label side of the disc. Do not insert discs that have adhesive remaining from tape or stickers that have been removed. If they are inserted into the player, they could stick to the internal mechanism, requiring removal by a technician.
- Never use a stabilizer. Using commercially available CD stabilizers with this unit will damage the mechanism and cause them to malfunction.
- Do not use cracked discs.
- Do not use CDs with an irregular shape (octagonal, heart shaped, business card size, etc.). CDs of this sort can damage the unit:



- Copy-protected discs and other discs which do not conform to the CD standard may not play back correctly in this player. If you use such discs in this unit, TEAC Corporation and its subsidiaries cannot be responsible for any consequences or guarantee the quality of reproduction. If you experience problems with such non-standard discs, you should contact the producers of the disc.

About CD-R and CD-RW discs

CD-R discs can be recorded once only. Once they have been used for recording, they cannot be erased or re-recorded. However, if space is available on the disc (and the disc has not been finalized), additional material can be recorded.

By contrast, a CD-RW disc can be used in much the same way as a CD-R disc, but the last track or tracks recorded can be erased, and the space on the disc can be re-used for other recordings.

However, you should note that an audio CD created using a CD-RW disc may not play back satisfactorily on every audio CD player.

CD-R, by contrast, may be played satisfactorily on the majority of audio CD players.

Inserting a disc into the slot-loading drive

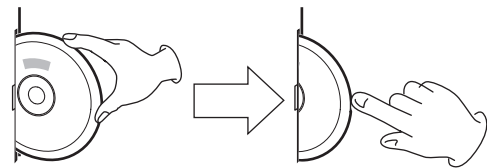

- 1. Insert a disc halfway into the slot by holding the disc edge and facing the label side front, as illustrated.**
- 2. Push the disc into the slot until the disc is automatically brought in.**

When a disc is not loaded properly

When a disc is not loaded properly, draw out the disc and press the **▲EJECT** key, then try to load it again. **DO NOT** push the disc in forcibly. It may damage the unit and the disc.

2-Quick start guide

Here introduces preparation of the unit and basic operations from playback to recording.

Preparation

Powering the unit

You can use the supplied AC adapter or separately purchased AA batteries. Connect the AC adapter or install the batteries before use.

Connecting the AC adapter

Connect the power cable to the AC adapter, the adapter to the unit, then connect the power cable to the AC outlet.

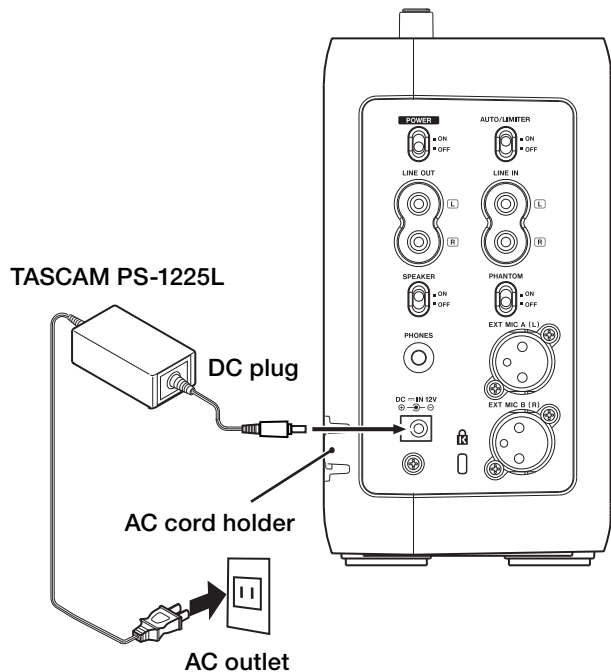

The left side panel of the unit has a dent for holding the cable of the AC adapter—the AC cord holder. Hook the cord in to the clipping of the holder to prevent unexpected disconnection of the cord.

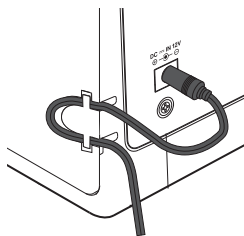

CAUTION

- DO NOT hook the AC cord in forcedly. It may damage the cord.
- Uninstall the batteries when using the supplied AC adapter to keep the battery life longer.

Installing the batteries

Take off the battery case cover and install separately purchased eight AA batteries observing the ⊕ and ⊖ marks on the case.

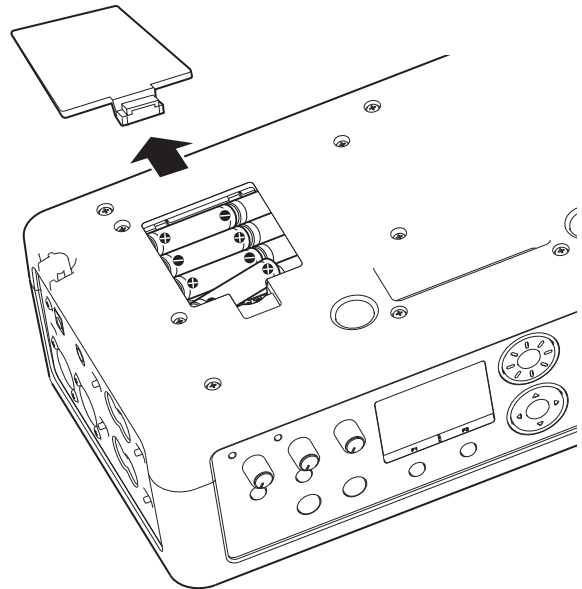

NOTE

Batteries are not supplied with this product. It is recommended to use Ni-MH or alkaline batteries.

Turning the power on and off

Turning on the power

Slide the **POWER** switch on the left side of the unit to **ON**. The Home screen will be displayed after the start-up screen disappears.

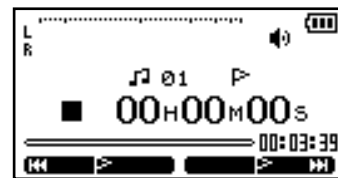

Turning off the power

Slide the **POWER** switch to **OFF**.

CAUTION

Do not turn off the power while the CD or SD indicator is flashing (during writing data).

Playing back a disc (commercially available audio CD)

Loading a disc

NOTE

You can load a disc while the unit is turned on.

1. Insert a disc halfway into the slot facing the label side front, as illustrated.

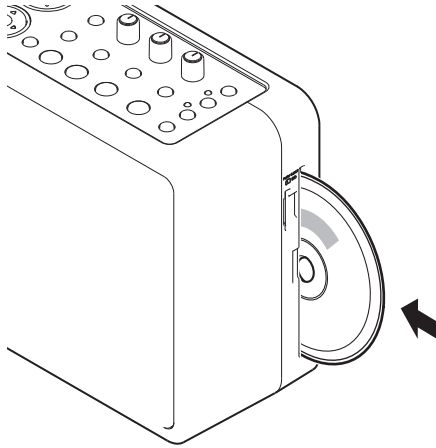

2. Push the disc into the slot until the disc is automatically brought in.

CAUTION

- You cannot insert a disc when the unit is turned off.
- When a disc is not loaded properly, draw out the disc and press the **EJECT** key, then try to load it again. **DO NOT** push the disc in forcibly. It may damage the unit and the disc.

Ejecting a disc

Press the **EJECT** key.

The disc is ejected halfway. Draw it out by holding its edge. Use the keys on the top of the unit to control playback.

CAUTION

You cannot eject a disc when the unit is turned off.

Selecting the playback media

Press the **CD** key on the unit while the Home screen is displayed to select it.

The recording/playback media is changed and the indicator of the selected media lights up.

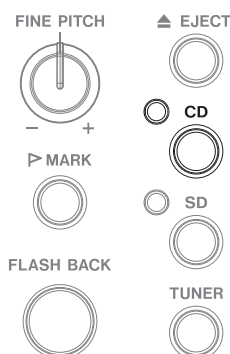

Playing back

Use the keys on the top of the unit to operate the BB-1000CD.

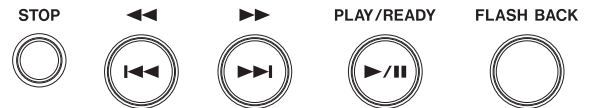

Press the **PLAY/READY** [▶/||] key to start playback.

Press the **PLAY/READY** [▶/||] key again to pause playback. Press the **STOP** key to stop playback.

Press the **▶▶** key to skip to the beginning of the next track. Press the **◀◀** key to skip to the beginning of the current track. Pressing it within the 1 seconds from the beginning of a track skips to the beginning of the previous track.

Press and hold the **▶▶/◀◀** key during playback/pause to search tracks forward/backward.

Press the **FLASH BACK** key during playback (or pause) to skip 2-second back the track.

NOTE

You can change the skip-back time when pressing the **FLASH BACK** key (→ page 50 "Adjusting the time of **FLASH BACK**").

Adjusting the volume

Turn the **VOLUME** knob on the top of the unit to adjust the volume.



Using the special playback control functions (changing pitch and speed of playback)

Turn the knobs on the top of the unit to adjust pitch and speed of playback.

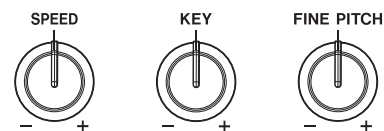

Turn the **SPEED** knob to adjust the playback speed without changing pitch.

Turn the **KEY** knob to adjust the playback pitch without changing speed.

For fine adjustment of pitch, use the **FINE PITCH** knob.

2-Quick start guide

Recording

Recording by using the built-in microphones is explained in the example below.

You can also use external microphones connected to the **EXT MIC A(L)/EXT MIC B(R)** terminals and audio equipment connected to the **LINE IN** terminal on the left side of the unit as recording sources.

1. Press the **INPUT** key to open the **INPUT** screen.

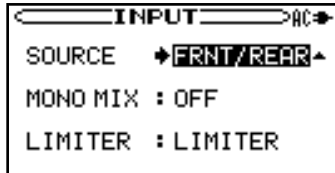

2. Press the **CURSOR** [▲/▼] key to select the **SOURCE** item.

3. Turn the **DATA** wheel to select "FRNT/REAR".

The built-in microphones on the front and rear (**FRONT MIC** and **REAR MIC**) are set to the recording source.

4. Press the **INPUT** key to return to the Home screen.

Inserting an SD card

The SD card slot and the CD slot are equipped on the right side of the unit.

Insert an SD card in the SD card slot and push it until it clicks fully into place.

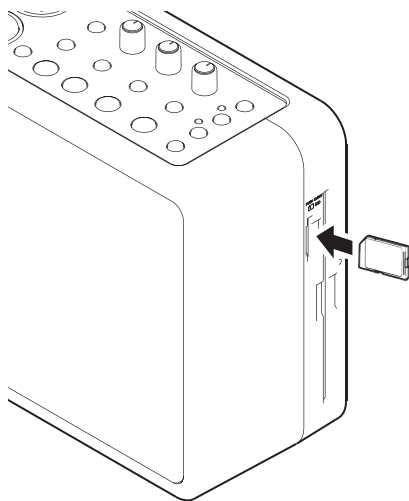

Removing the SD card

Press the inserted SD card gently and it will disengage from the unit so that you can completely pull it out.

NOTE

Do not remove the SD card during recording and playback, and while the SD indicator is flashing (writing data).

Recording on an SD card

Before recording, insert an SD card into the unit and press the **SD** key to change the recording media to SD card.

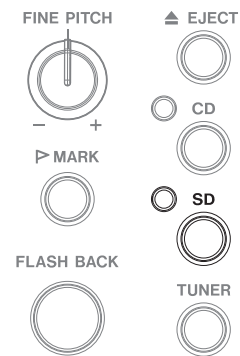

NOTE

It is recommended to format an SD card on the unit before recording on the card (→ page 49 "Formatting an SD card"). Using an SD card formatted on other devices or a PC may increase the possibility of recording errors.

1. Press the **REC/READY** [●] key.

The unit becomes on standby for recording. The **Record** screen appears and **REC/READY** [●] key flashes.

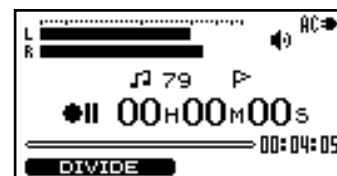
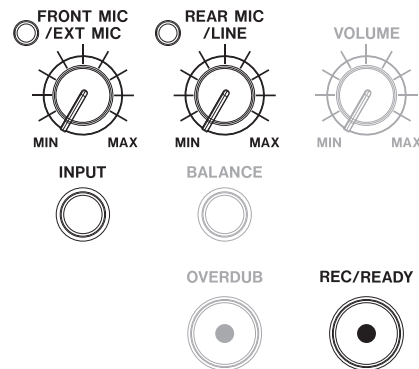

2. Check the level meter and adjust the input level by turning the **FRONT MIC/EXT MIC** knob and the **REAR MIC/LINE** knob.

The input level is indicated on the **L/R** meter.



The indicators upper left of the knobs light when the input is too loud. Set the input level a little less than that makes the indicators lit at inputting maximum volume.

2-Quick start guide

3. Press the REC/READY [●] key to start recording.

The REC/READY [●] key lights during recording.

4. Recording stops when pressing the STOP key during recording or recording-on-standby. The REC/READY [●] key goes off.

- Pressing the REC/READY [●] key during recording returns the unit on standby for recording. The REC/READY key flashes during recording-on-standby.

Recording on a new track starts as you press the REC/READY [●] key again. The REC/READY [●] key lights steadily.

NOTE

You can play the last recorded file if you press the PLAY/READY [▶/||] key directly after stopping recording by pressing the STOP key.

Recording on a disc

Before recording, load a CD-R or CD-RW into the unit and press the CD key to change the recording media to CD.

CAUTION

You cannot record on a disc when using the unit with battery power. Supply the power through the AC adapter.

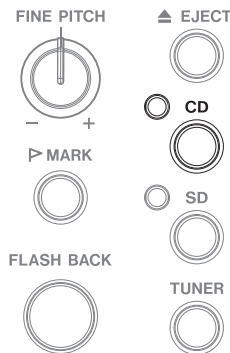

1. Press the REC/READY [●] key.

The unit becomes on standby for recording. The Record screen appears and REC/READY [●] key flashes.

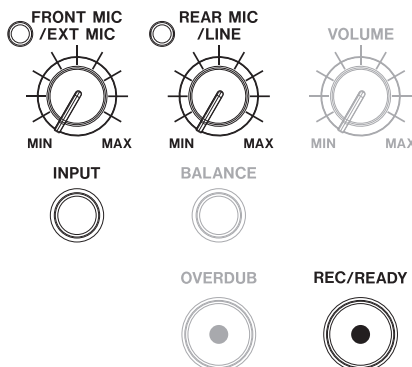

2. Check the level meter and adjust the input level by turning the FRONT MIC/EXT MIC knob and the REAR MIC/LINE knob.

The input level is indicated on the L/R meter.



The indicators upper left of the knobs light when the input is too loud. Set the input level a little less than that makes the indicators lit at inputting maximum volume.

3. Press the REC/READY [●] key to start recording.

The REC/READY [●] key lights during recording.

4. Recording stops when pressing the STOP key during recording or recording-on-standby. The REC/READY [●] key goes off.

- Pressing the REC/READY [●] key during recording returns the unit on standby for recording. The REC/READY key flashes during recording-on-standby.

Recording on a new track starts as you press the REC/READY [●] key again. The REC/READY [●] key lights steadily.

NOTE

You can play the last recorded track if you press the PLAY/READY [▶/||] key directly after stopping recording by pressing the STOP key.

CAUTION

To playback a disc recorded on the unit on another device, you need to finalize it.

2-Quick start guide

Ejecting a disc

Press the **EJECT** key to eject a disc. A finalization confirmation message appears when ejecting a disc not finalized yet.



Press the **F1** key to finalize it. Press the **F2** key to eject it without finalization.

NOTE

You can finalize a disc without its ejection (→ page 47 "Finalizing a disc").

Recordable discs:

You can use a CD-R or CD-RW disc for recording. CD-R discs can be recorded once only. Once they have been used for recording, they cannot be erased or re-recorded. However, if space is available on the disc (and the disc has not been finalized), additional material can be recorded. A recorded CD-R disc can be played on a standard CD players after finalization (some CD players may not play back the disc even after finalization).

CD-RW discs can be reused even after fully recorded by erasing the existing tracks. The erasable track is the final one/ones; you cannot erase the track/tracks-in-between only. CD-RW discs may be unplayable on some players even after finalization.

3-Part Names and Functions

Top panel

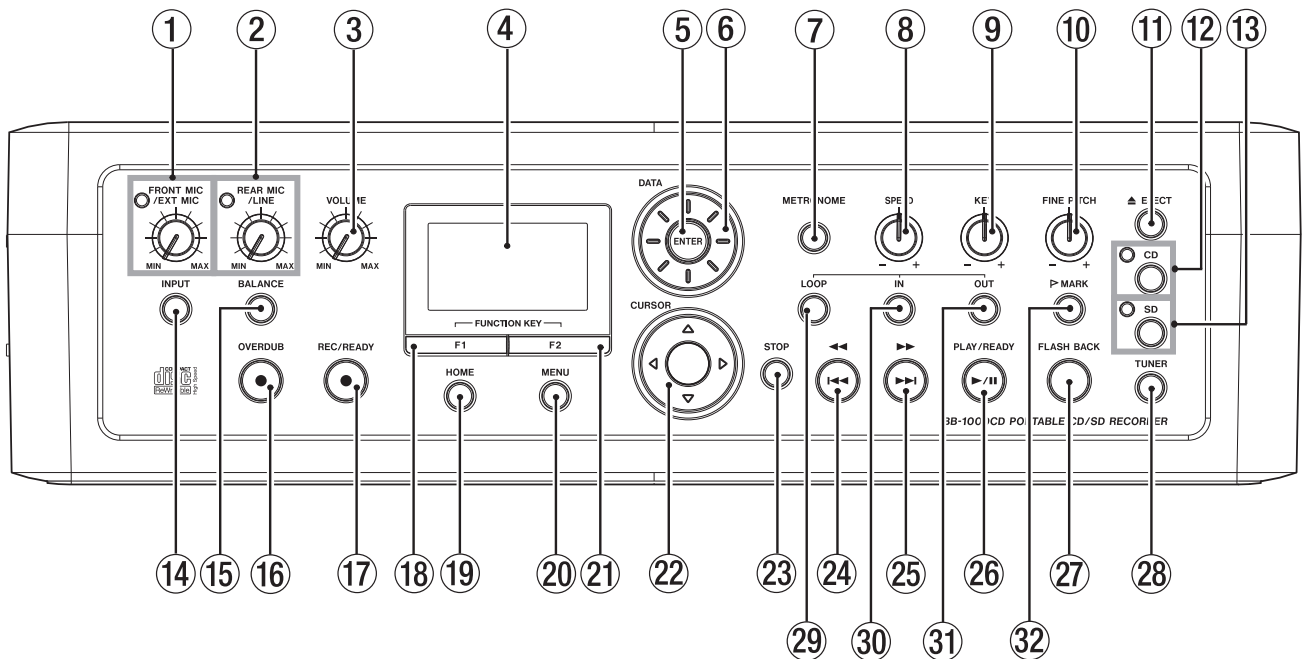

- ① **FRONT MIC/EXT MIC knob/Excessive input indicator**
Use this knob to adjust the input level of the front built-in microphones (**FRONT MIC**) or external microphones. The indicator on the upper left lights when the input level is too high.
- ② **REAR MIC/LINE knob/Excessive input indicator**
Use this knob to adjust the input level of the rear built-in microphones (**REAR MIC**) or the signal from the **LINE IN** terminal. The indicator on the upper left lights when the input level is too high.
- ③ **VOLUME knob**
Use this knob to adjust the speaker volume and the output level of headphones and lineout signals.
- ④ **Display**
This shows various information such as the selected media, recording/playback signal level, data transfer status, setting menus, etc.
- ⑤ **ENTER key**
Use this key to confirm the selection during operations on the setting screen.
- ⑥ **DATA wheel**
When a setting screen is open, use the wheel to change the setting of the selected item.
When the Home screen is open, use the wheel to adjust the file playback position.
- ⑦ **METRONOME key**
Press this key to use the metronome function (**METRONOME** screen.)
When the **METRONOME** screen is displayed, press this key to return to the Home screen.
- ⑧ **SPEED knob**
Use this knob to adjust playback speed.
- ⑨ **KEY knob**
Use this knob to adjust the playback pitch of playback.
- ⑩ **FINE PITCH knob**
Use this knob for fine adjustment of playback pitch.
- ⑪ **▲ EJECT key**
Press this key to eject a disc.
- ⑫ **CD key/CD indicator**
When the Home screen is displayed, press this key to change the recording/playback media to CD. The indicator lights when CD is selected.
- ⑬ **SD key/SD indicator**
When the Home screen is displayed, press this key to change the recording/playback media to SD card. The indicator lights when SD card is selected.
- ⑭ **INPUT key**
Press this key to open the Input Setting (**INPUT**) screen. When the **INPUT** screen is displayed, press this key to return to the Home screen.
- ⑮ **BALANCE key**
Press this key to open the Input Balance Setting (**BALANCE**) screen. When the **BALANCE** screen is displayed, press this key to return to the Home screen.

3-Part Names and Functions

- ⑩ **OVERDUB** key
Press this key when recording a mixed sound of CD/SD playback and other input signals (overdubbing).
The unit becomes on standby for overdubbing by pressing the key and the key lights during on standby.
- ⑪ **REC/READY** [●] key
Press this key to make the unit on standby for recording. The key is flashing while on standby. The key lights during recording.
During recording, press this key to make the unit on standby for recording.
- ⑫ **F1** key
This key works variously depending on the status of the unit; confirming of the selection, returning to the previous step. etc. The function of the **F1** key is indicated on left bottom of the display.
- ⑬ **HOME** key
Press this key to return to the Home screen while displaying another screen.
- ⑭ **MENU** key
When the Home screen is displayed, press this key to open the menu list (**MENU** screen).
When a setting screen is displayed, press this key to return to the **MENU** screen.
- ⑮ **F2** Key
This key works variously depending on the status of the unit; confirming of the selection, returning to the previous step. etc. The function of the **F2** key is indicated on right bottom of the display.
- ⑯ **CURSOR** [▲/▼/◀/▶] key
Press this key to move the cursor (highlighted area) on a setting screen.
- ⑰ **STOP** key
Press this key to stop playback. The track returns to its beginning.
- ⑱ ◀◀/◀◀ key
Press this key within 1 seconds from the beginning of a track to skip to the beginning of the previous track. Pressing it at more than 1 seconds after the beginning of a track skips to the beginning of the current track.
Press and hold this key to fast-reverse the tracks.
Pressing this key during loop playback slides the end point of the loop back to its start point, keeping the time length of the loop.
- ⑲ ▶▶/▶▶ key
Press this key to skip to the next track.
Press and hold this key to fast-forward the tracks.
Pressing this key during loop playback slides the start point of the loop forward to its end point, keeping the time length of the loop.
- ⑳ **PLAY/READY** [▶/||] key
When the Home screen is displayed and playback is stopped, press this key to start playback.
During playback, press this key to pause it.
- ㉑ **FLASH BACK** key
Press this key to skip a few seconds back the track during playback (or pause). You can adjust the skip back time at the **SET UP** screen (→ page 36 “Skipping a track a little backward (**FLASH BACK**)”).
- ㉒ **TUNER** key
Press this key to open the **TUNER** screen. You can use the unit as a chromatic tuner for instrument (→ page 41 “Chromatic tuner mode”).
When the **TUNER** screen is displayed, press this key to return to the Home screen.
- ㉓ **LOOP** key
Use this key to activate/deactivate the loop playback when the start point and end point of playback has been set (→ page 37 “Loop playback (I-O LOOP)”).
Use this key to activate/deactivate repeat playback when the points are not set (→ page 37 “Repeat playback”).
Press **IN/OUT/MARK** key while pressing and holding this key to clear the start/end/marker point, respectively.
- ㉔ **IN** key
Use this key to set the start point of the loop playback. Press this key while pressing and holding the **LOOP** key to clear the start point (→ page 37 “Loop playback (I-O LOOP)”).
- ㉕ **OUT** key
Use this key to set the end point of the loop playback. Press this key while pressing and holding the **LOOP** key to clear the end point (→ page 37 “Loop playback (I-O LOOP)”).
- ㉖ ▷ **MARK** key
Use this key to set the marker point where playback starts. Press this key while pressing and holding the **LOOP** key to clear the marker point on the Home screen. (→ page 36 “Playback from marked point”).

3-Part Names and Functions

Front Panel

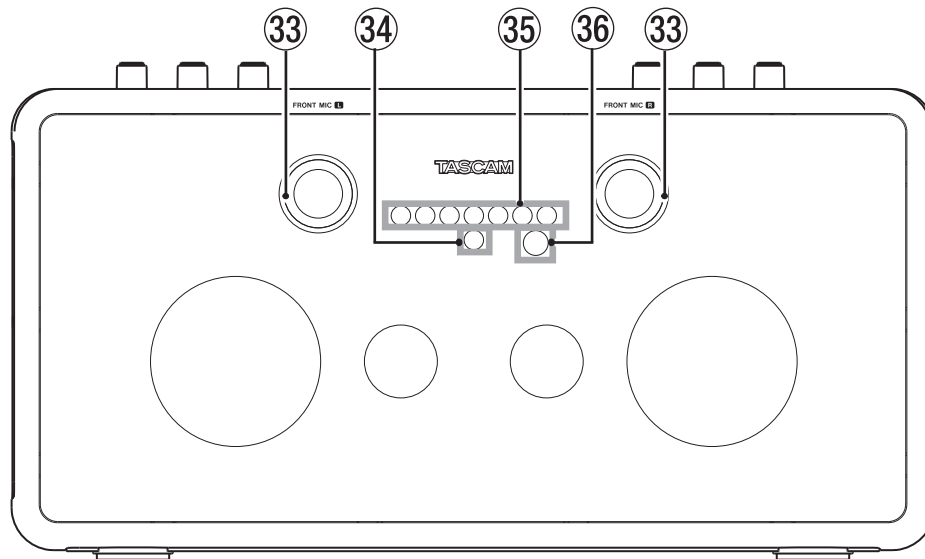

33 FRONT MIC L/R

Built-in stereo microphones.

The left microphone also functions as the tuning microphone.

34 Power indicator

The indicator lights when the unit is turned on.

35 Volume/playback/recording indicator

When adjusting the volume, the indicator shows the volume by the number of green lights.

The center LED lights in green during playback.

The center LED lights in red during recording.

While using the metronome function, the green light moves left and right along with its time.

While using the chromatic tuner function, the LED indicates the pitch difference from the reference tone.

36 Remote sensor

This receives the signals from the supplied remote control unit (RC-BB1000). Aim the head of the remote control unit to the sensor when operating the unit with it (→ page 27 “Remote control unit (RC-BB1000)”).

Rear Panel

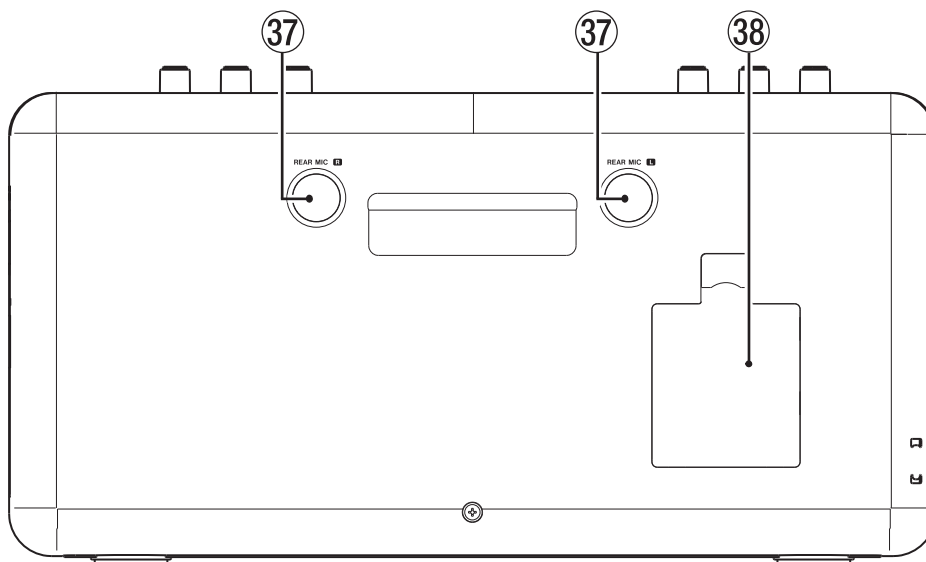

37 REAR MIC L/R

Built-in stereo microphones.

38 Battery case

The case holds 8 AA batteries.

Inside of the battery case

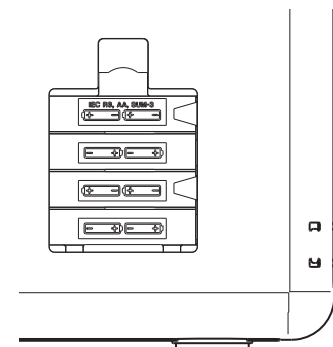

3-Part Names and Functions

Left side panel

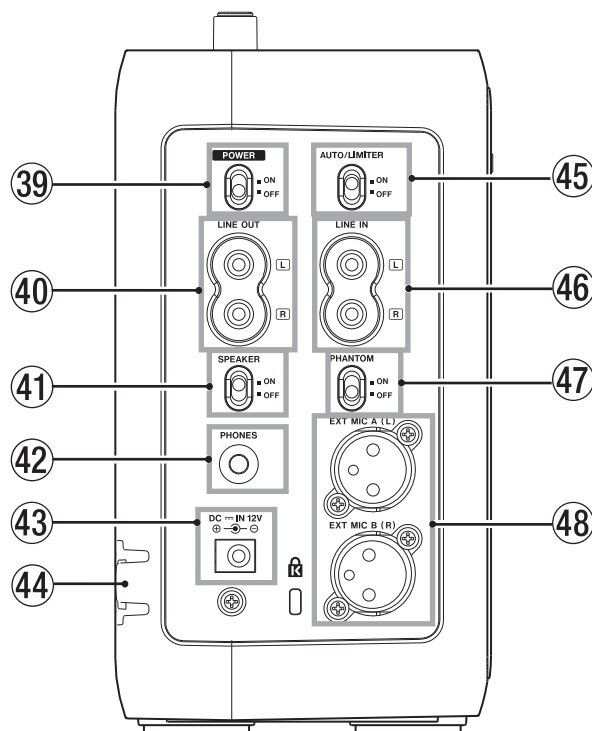

39 POWER switch

Use this switch to turn on/off the power.

40 LINE OUT jack

Use this to connect an electronic instrument with speakers, audio equipment, powered speakers, etc.

41 SPEAKER switch

Use this switch to turn on/off the built in speakers.

42 PHONES jack

Use this to connect headphones.

43 DC IN 12V jack

Connect the supplied AC adapter to this jack.

44 AC cord holder

This holds the AC cord to prevent unexpected disconnection of the cord.

45 AUTO/LIMITER switch

Use this to activate/deactivate the **LIMITER** function.

46 LINE IN jack

Use this to connect with the line out jack on an electronic instrument or an external audio device such as a CD player.

47 PHANTOM switch

Slide this switch to **ON** when supplying the power (+48 V) to the microphones connected to the **EXT MIC** jacks.

CAUTION

*Do not connect/disconnect a microphone when the **PHANTOM** switch is ON.*

48 EXT MIC A(L)/EXT MIC B(R) jacks

Use the **XLR** jacks to connect external microphones. The pin configuration of the XLR connector is: #1=ground, #2=hot, #3=cold.

3-Part Names and Functions

Right side panel

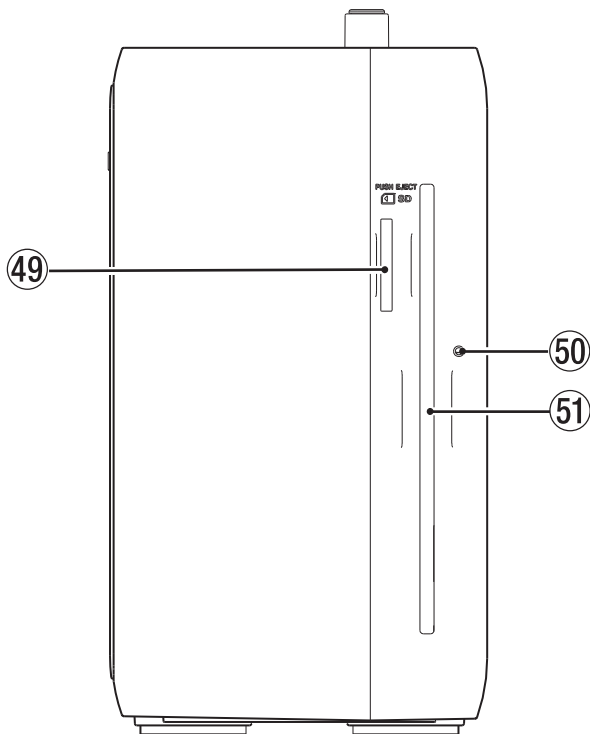

- ④⑨ SD card slot
Insert an SD card into this slot.
- ⑤⑩ Force disc ejection hole
Use this to eject a disc when the CD drive malfunctions and cannot eject the disc (→ page 31 “Ejecting a disc forcibly”).
- ⑤⑪ CD slot
Insert a CD into this slot.

Remote control unit (RC-BB1000)

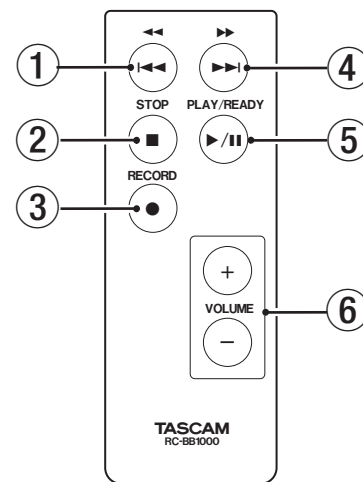

- ① ◀◀ / ▶▶ key
Press this key within 1 seconds from the beginning of a track to skip to the beginning of the previous track. Pressing it at more than 1 seconds after the beginning of a track skips to the beginning of the current track.
Press and hold this key to fast-reverse the tracks.
Pressing this key during loop playback slides the end point of the loop back to its start point, keeping the time length of the loop.
- ② STOP [■] key
Press this key to stop playback. The track returns to its beginning.
- ③ RECORD [●] key
Press this key to make the unit on standby for recording.
Press this key to start recording while on standby for recording.
- ④ ▶▶ / ▶▶▶ key
Press this key to skip to the next track.
Press and hold this key to fast-forward the tracks.
Pressing this key during loop playback slides the start point of the loop forward to its end point, keeping the time length of the loop.
- ⑤ PLAY/READY [▶/||] key
When the Home screen is displayed and playback is stopped, press this key to start playback.
During playback, press this key to pause it.
- ⑥ VOLUME [+/-] keys
Use these keys to adjust the volume.

4-Preparation

Powering the unit

You can use the supplied AC adapter or separately purchased AA batteries as the power source. Connect the AC adapter or install the batteries before use.

CAUTION

You cannot record on a disc when using the unit with battery power. Supply the power through the AC adapter.

Connecting the AC adapter

Connect the power cable to the AC adapter, the adapter to the unit, then connect the power cable to the AC outlet.

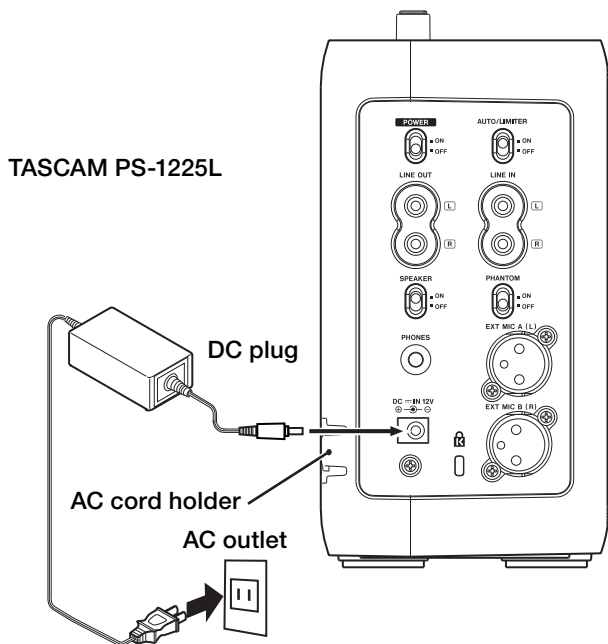

The left side panel of the unit has a dent for holding the cable of the AC adapter—the AC cord holder. Hook the cord in to the clipping of the holder to prevent unexpected disconnection of the cord.

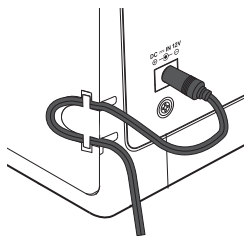

CAUTION

- DO NOT hook the AC cord in forcibly. It may damage the cord.
- Uninstall the batteries when using the supplied AC adapter to keep the battery life longer.

Installing the batteries

Take off the battery case cover and install separately purchased eight AA batteries observing the ⊕ and ⊖ marks on the case.

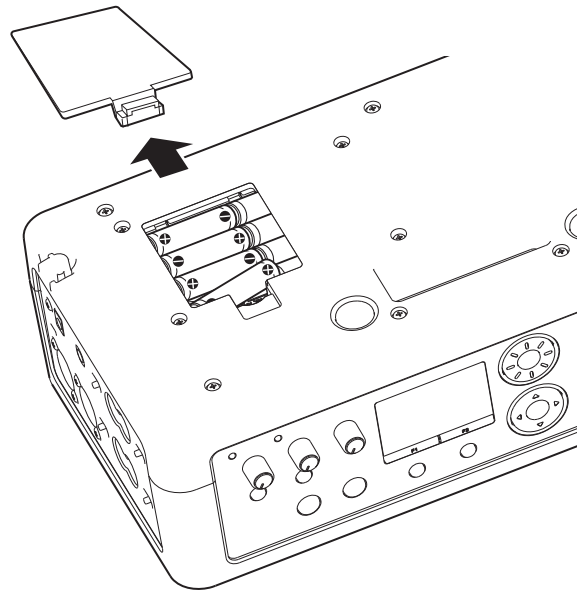

NOTE

Batteries are not supplied with this product. It is recommended to use Ni-MH or alkaline batteries.

Remote control unit

Installing the battery

1. Pull out the battery holder.

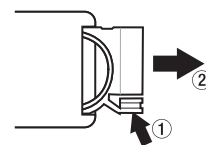

2. Install a lithium coin battery (CR2025) facing the + side up.

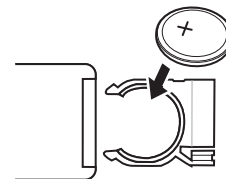

3. Put in the battery holder.

Battery replacement

Replace the battery when the operatable range decreases or the unit becomes unoperatable through the remote control unit.

Use a lithium coin battery (CR2025) for replacement.

Precautions concerning batteries

- Small children may mistakenly swallow a lithium coin battery and it is very dangerous. Keep the battery and the remote control out of the reach of small children. In the event a battery is swallowed, immediately consult a physician.
- Install batteries with matching the polarity correctly.
- Do not charge the battery.
- Do not heat or disassemble batteries. Do not put them in fire or water.
- Do not carry or store batteries together with small metal objects. The batteries could short, causing leak, rupture or other trouble.

Precautions using the remote control unit

- Remove the batteries if you do not plan to use the remote control for a long time (longer than a month).
- If the battery fluid leaks, wipe away any fluid on the battery case before inserting a new battery.
- Using the remote control unit while other equipment controllable with infrared ray is turned on may cause malfunction of the equipment.
- Aim the remote control unit at the remote sensor. An obstacle may interfere operations through the remote control unit.

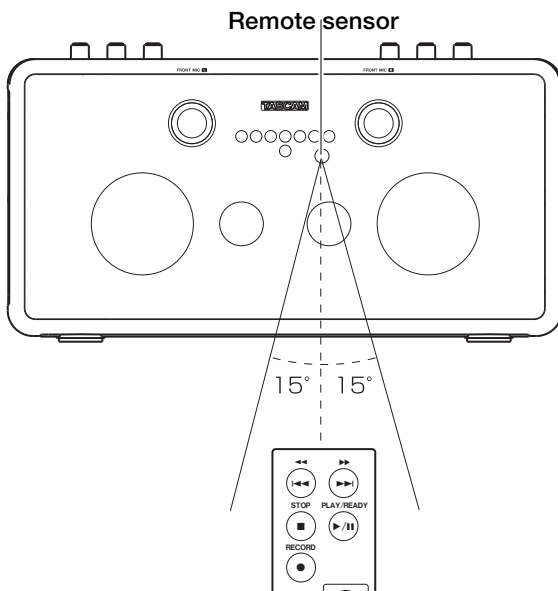

Operating distance
 Head-on to the sensor: 7 m
 15° left/right from the sensor: 4 m

Turning the power on and off

Turning of the power

Slide the **POWER** switch on the left side of the unit to **ON**. The Home screen will be displayed after the start-up screen disappears.

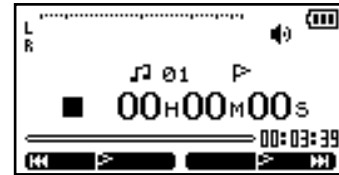

Turning off the power

Slide the **POWER** switch to **OFF**.

CAUTION

Do not turn off the power while a media indicator (CD or SD) are flashing (during writing data).

Setting the date and time

Set the date and time of the built-in clock. The time information of the files made by this unit is based on the clock.

1. Press the **MENU** key to open the **MENU** screen.



2. Use the **CURSOR** [**▲/▼**] key to select **SETUP** and press the **ENTER** key.

The **SETUP** screen appears.



3. Use the **CURSOR** [**▲/▼**] key to select **DATE/TIME** and press the **ENTER** key.

The **DATE/TIME** screen appears.

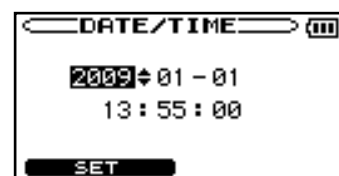

The clock stops while this screen is displayed.

4-Preparation

4. Use the DATA wheel to adjust the value and press the CURSOR [▶] key .

The cursor moves to the next place.

5. After making the setting, press the F1 key to restart the clock from the newly set value.

The display returns to the SETUP screen.

NOTE

You cannot see the time and date information of audio files on the unit.

Inserting an SD card

Insert an SD card and push it until it clicks fully into place.

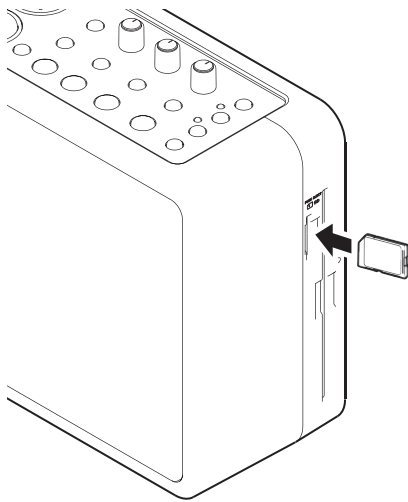

Removing the SD card

Press the inserted SD card.

NOTE

Do not remove the SD card during recording and playback, and while the SD indicator is flashing (writing data).

When using a new SD card

When using a new SD card, it is recommended to format it on the unit before starting to use it. (→ page 49 “Formatting an SD card”).

Using an SD card formatted on other devices or a PC may increase the possibility of recording errors.

CAUTION

Take enough care when formatting as all the data on an SD card, including those written by other equipment, will be erased.

Write protection

An SD card has the write protection switch. When you try to record on a protected card, the error message “Protected Card” appears and you cannot record on it.

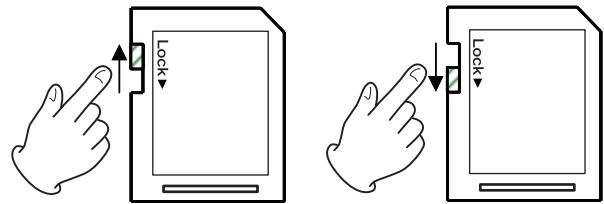

[Unprotected]

[Protected]

NOTE

The error message appears only when you try to record on a protected SD card. No message appears when the unit tries and fails to write information such as the order of audio files and the position of markers on the protected SD card.

Loading a disc

NOTE

You can load a disc while the unit is turned on.

1. Insert a disc halfway into the slot facing the label side front, as illustrated.

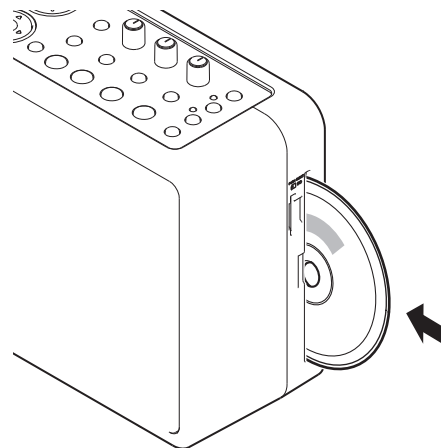

2. Push the disc into the slot until the disc is automatically brought in.

CAUTION

- You cannot insert a disc when the unit is turned off.
- When a disc is not loaded properly, draw out the disc and press the ▲EJECT key, then try to load it again. DO NOT push the disc in forcibly. It may damage the unit and the disc.

Ejecting a disc

Press the **▲EJECT** key.

The disc is ejected halfway. Draw it out by holding its edge.

CAUTION

You cannot eject a disc when the unit is turned off.

NOTE

A finalization confirmation message appears when ejecting a disc not finalized yet.

Ejecting a disc forcibly

You can eject a disc forcibly by using the hole for force eject when the **▲EJECT** key does not work because of malfunction of the disc drive.

To eject a disc forcibly, Turn off the unit and follow the procedure below.

1. Prepare a long pin such as a stretched paper clip.
2. Insert the pin into the hole for force eject and push it in several times.
3. Pull the disc out by hand when it is pushed halfway out.

CAUTION

DO NOT eject a disc forcibly by using the hole for force eject when the unit is turned on.

Selecting the recording/playback media

Select a recording/playback media (disc or SD card) before you start using the unit.

Press the **CD** key or the **SD** key on the unit while the Home screen is displayed and playback is stopped to select it.

The recording/playback media is changed and the indicator of the selected media lights up.

5-Screen Overview

When the unit is ordinarily playing or stopped, the Home screen appears on the display. Setting screens appear when making various settings, and the Record screen appears when the unit is recording or in recording standby.

Home screen

The items that appear on the Home screen are explained below. See the explanations later in this chapter for the setting screens and the Record screen.

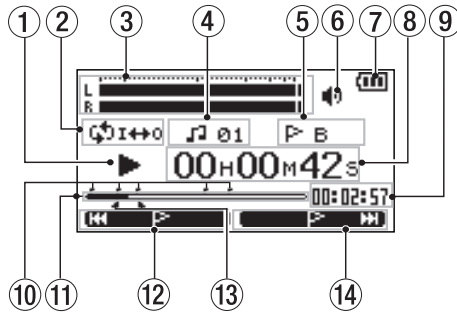

① Unit status

This icon show the current operation status.

- ▶ Track playing
- ⏸ File stopped in progress (paused)
- File stopped at its beginning
- ▶▶ Fast forwarding
- ◀◀ Fast rewinding
- ▶▶▶ Skipping to the beginning of the next track
- ◀◀◀ Skipping to the beginning of the current or previous track
- ⌘ File dividing mode

② Loop/repeat setting status

The following icons appear depending on the current loop/repeat setting.

- 🔄 Repeat playback
- 🔄 I+0 Loop repeat active

③ Level meter

During playback, the signal level of the playback track is indicated.

The right end of the meter lights up for a while when the signal level is too high.

④ File number

The number of the file currently played back is indicated.

⑤ Marker name

The name of the nearest marker of those which position previous of the current playback position is indicated.

⑥ Speaker output status

The speaker output status is indicated.

- 🔊 Built-in speakers ON
- 🔊 Built-in speakers OFF
- 🎧 Headphones connected

⑦ Battery status

When batteries are being used, a battery icon shows the amount of power remaining in bars (▬, ▬, ▬). The batteries are almost dead and the power will soon turn off if the icon has no bars ▬. When using the AC adapter ⏻ appears.

⑧ Elapsed time

Shows the elapsed time (hours: minutes: seconds) of the currently playing track.

⑨ Remaining time

Shows the remaining playback time of the current track (hours: minutes: seconds).

⑩ Marker positions

The positions of markers are indicated.

The ▬ icons on the playback position display bar indicates the positions of markers.

⑪ Playback position display bar

This bar shows the current playback position. The bar darkens from the left as playback proceeds.

⑫ Current function of the F1 key

This shows the function currently assigned to the F1 key. On the Home screen, pressing it skips playback to the nearest previous marker.

⑬ Status of loop IN and OUT points

This shows the status of the IN and OUT point settings for loop playback.

If an IN point is set, the ▬ icon appears under the display bar at the position equivalent to the playback location.

If an OUT point is set, the ▬ icon appears under the display bar at the position equivalent to the playback location.

⑭ Current function of the F2 key

This shows the function currently assigned to the F2 key. On the Home screen, pressing it skips playback to the next marker.

Record screen

This screen opens when you press the **REC/READY** [●] key to start recording standby mode and stays open when you press the **REC/READY** [●] key again to start recording.

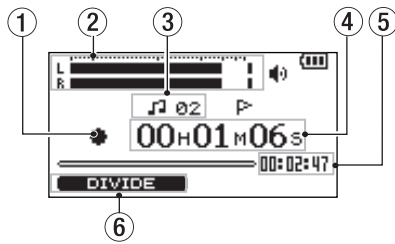

① Recorder operation

- Recording
- ⏸ Recording paused
- Recording stopped

② Record level meter

The input signal level of the selected input appears as separate L and R channels. The right end of the meter lights up for a while when the signal level is too high.

③ File number

The number of the file currently recorded is indicated.

④ Elapsed recording time

The elapsed recording time appears in hours: minutes: seconds.

⑤ Remaining recording time

The remaining recording time appears in hours: minutes: seconds.

⑥ Current function of the F1 key

This shows the function currently assigned to the **F1** key. On the Recording screen, pressing it divides the recording file.

Setting screens

Use this unit's various setting screens to make various settings, conduct operations and show information.

NOTE

Although the various setting screens are also used to execute functions and display information, for example, in addition to making settings, we call them "setting screens" in this manual.

Setting screen structure

Most of the setting screens are accessed by first pressing the **MENU** button to open the **MENU** screen, but some screens can also be accessed directly using dedicated keys. See also the setting screen list on the next page.

Operation basics

Use the **MENU**, **CURSOR** [▲/▼/◀/▶], **ENTER**, **F1**, **F2** and **HOME** keys and the **DATA** wheel to conduct most operations on the various setting screens.

The keys have the following functions.

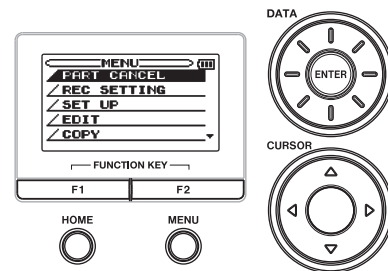

MENU key:

Press this key to open the **MENU** screen (except when the **MENU** screen is already open or the Record screen is open). When the **MENU** screen is open, press this key to return to the Home screen. This key is inoperative when the Record screen is open.

CURSOR [▲/▼] key:

Use this key to select an item.

CURSOR [◀] key:

When a setting screen is open, moves the cursor (part highlighted in inverse) to the left within the screen.

CURSOR [▶] key:

When a setting screen is open, moves the cursor (part highlighted in inverse) to the right within the screen. In many cases, the **ENTER** key can also be used this way.

ENTER key:

Use this key to confirm the selection.

F1/F2 key:

Use these keys to switch a setting screen to another and to select **YES/NO** or **BACK/NEXT** for answering a confirmation message.

HOME key:

When a setting screen is open, press to return to the Home screen.

DATA Wheel:

Use this to change the value of the selected item.

5-Screen Overview

Operation example

See an operation example below: changing “FLASH BACK time” on the **SETUP** menu.

1. When the Home screen is displayed, press the **MENU** key to open the **MENU** screen.

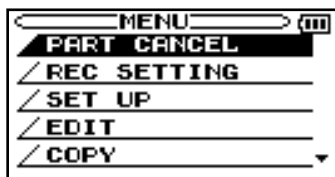

NOTE

When the ▼ icon appears in the lower right part of the screen, as shown in the preceding image, there is additional information for the current screen below what is shown on the display.

When the ▲ icon appears, there is additional information for the current screen above what is shown on the display.

2. Press the **CURSOR [▲/▼]** key to select **SET UP** (highlighted in inverse), and press the **ENTER** key to open the **SETUP** screen.



3. Use the **CURSOR [▲/▼]** key to select **FLASH BACK** and show the current setting value (the factory setting is “2sec”) highlighted in inverse.
4. Turn the **DATA** wheel to select the desired setting. The setting is changed immediately, so there is no need to press the **ENTER** key again to confirm it.

NOTE

When the ▲ icon appears to the right of a setting value, you can change that value by turning it to the right. When the ▼ icon appears to the right of a setting value, you can change that value by turning it to the left.

Setting screen list

Screen	Overview	Access method
PART CANCEL	Decreasing the sound of vocal and guitar.	MENU key → MENU screen
REC SETTING	Adjusting recording settings such as auto-recording and file format.	MENU key → MENU screen
SET UP	Adjusting environmental settings	MENU key → MENU screen
DATE/TIME	Adjusting the built-in clock	MENU key → MENU screen → SET UP screen
EDIT	Editing files: dividing, moving, and deleting	MENU key → MENU screen
COPY	Copying files between a disc and an SD card	MENU key → MENU screen
MEDIA	Finalizing and unfinalizing a disc, deleting tracks, browsing files on an SD card, formatting an SD card	MENU key → MENU screen
BROWSE	Browsing audio files and folders, playing/deleting files, making/selecting a folder	MENU key → MENU screen → MEDIA screen
INPUT	Selecting an input and adjusting the input settings	INPUT key
BALANCE	Adjusting left and right balance of input signals and setting the volume of the playback signal	BALANCE key
METRANOME	Set and operate metronome functions	METRANOME key
TUNER	Access tuner and oscillator functions	TUNER key

Connecting monitors

You can connect headphones to the **PHONES** jack (stereo mini jack) and an external audio device (powered speakers, audio system, etc) to the **LINE OUT** jack (RCA jack) for monitoring.

Powered speakers,
stereo system, etc.

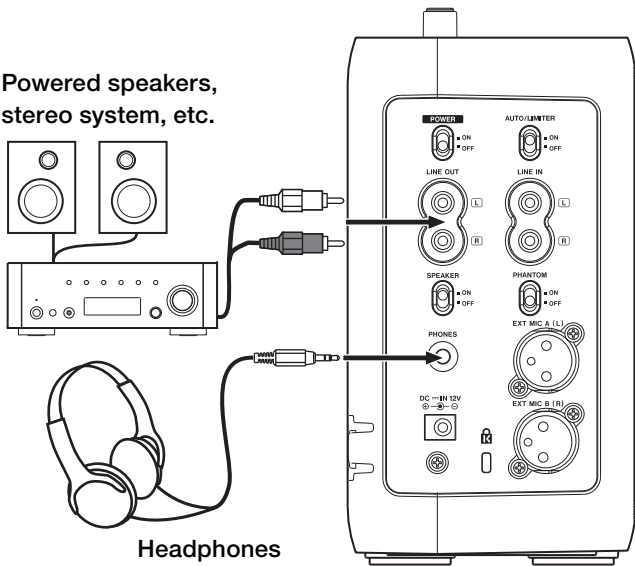

Headphones

NOTE

Slide the **SPEAKER** switch to **OFF** to deactivate the built-in speakers. The built-in speakers are automatically deactivated as headphones are connected to the **PHONES** jack regardless of the switch's position.

CAUTION

The sound through microphones (both built-in and external) does not come out of the built-in speakers. Use headphones when you want to monitor it.

Connecting external microphones and an audio device

The unit can record sounds from external audio equipment as well as the built-in stereo microphones and you can record sounds using them. You can connect the equipment to the **LINE IN** jack and the external microphone jacks. See below how to connect them (For settings of the connections and input level, see "8-Recording").

Connecting to the EXT MIC jacks

You can connect microphones to the **EXT MIC A (L)** and **EXT MIC B (R)** jacks (XLR jacks) on the left side of the unit.

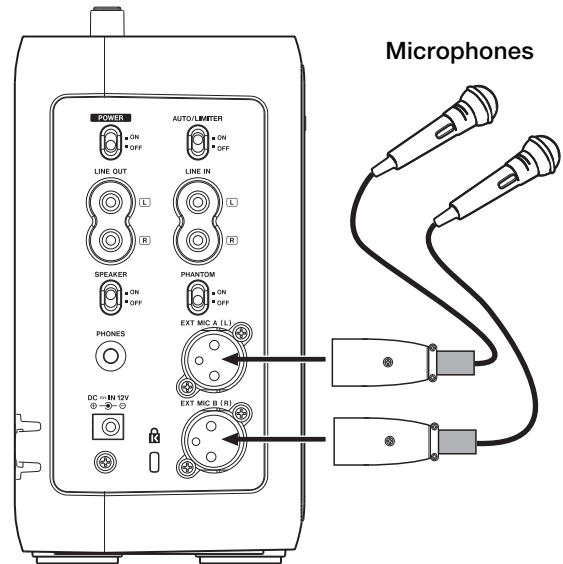

Microphones

CAUTION

- Slide the **PHANTOM** switch to **ON** after connecting microphones which need power supply, such as condenser microphones. Turn the switch off when using other types of microphones, such as dynamic ones. Otherwise the microphones may be damaged. Refer to the manual of the microphones for details.
- Do not connect/disconnect a microphone when the **PHANTOM** switch is **ON**.

Connecting to the LINE IN jack

You can connect the line output of an audio device to the **LINE IN** jack (RCA jack).

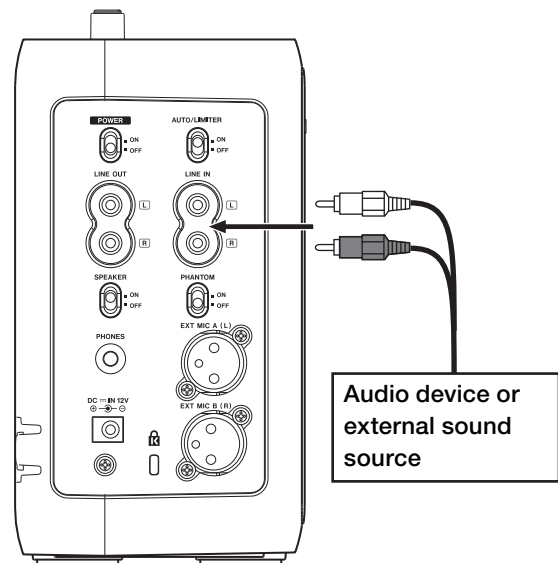

Audio device or
external sound
source

7-Playback

Playable file format

This unit can play back audio CDs and MP3 files (32 - 320 kbps, 44.1 kHz) and WAV files (44.1 kHz, 16 bit) on an SD card.

Playback



When the Home screen is displayed, use the **PLAY/READY** [▶/||], ◀◀ and ▶▶ keys to operate the BB-1000CD as you would with an ordinary CD player or other audio device. Use the **DATA** wheel to change the playback position.

NOTE

When the Home screen is not displayed, these keys and the **DATA** wheel have different functions.

Changing the recording/playback media

Press the **CD** key to change the recording/playback media to CD.

Press the **SD** key to change the recording/playback media to SD card.

The indicator of the selected source lights.

NOTE

- Stop playback before changing the media. You cannot change the media during playback, recording, and pause.
- The unit plays only files in a folder which contains the currently playing file when you are using an SD card. To play a file in another folder, select the folder on the **BROWSE** screen (→ page 48 "Browsing an SD card").

Play a track

When playback is stopped, press the **PLAY/READY** [▶/||] key to start playback.

Pause playback

During playback, press the **PLAY/READY** [▶/||] key to pause it at the current position.

Stop playback

Press the **STOP** key to stop playback. The track returns to its beginning.

Selecting tracks

Use the ◀◀ and ▶▶ keys to select tracks both during playing and when playback is stopped.

During playback or when a track is stopped in the middle, press the ◀◀ key to return to the beginning of the current track.

Pressing the ◀◀ key within the 1 seconds from the beginning of a track skips to the beginning of the previous track.

When stopped at the beginning of a track, press the ◀◀ key to skip to the beginning of the previous track, or press the ▶▶ key to skip to the beginning of the next track.

NOTE

The ■ icon appears on the display when playback is stopped at the beginning a track, and the || icon appears when playback is stopped in the middle of a track (paused).

Search forward and backward

Press and hold the ◀◀ key to search backwards or the ▶▶ key to search forwards.

Using the DATA wheel to change the playback position

You can use the **DATA** wheel to adjust the playback position within a track. When you turn the wheel, the position in the playback position display bar changes, so you can visually confirm that the playback position has been moved.

NOTE

Playback continues normally while the **DATA** wheel is moving when you move it during playback. The playback skips to the position the wheel assigned as it stops.

Skipping a track a little backward (FLASH BACK)

Press the **FLASH BACK** key to skip a few seconds back the track during playback (or pause). You can adjust the skip back time from 1 to 5 seconds by changing the **FLASH BACK** setting on the **SET UP** screen (→ page 50 "Adjusting the time of FLASH BACK").

Playback from marked points

You can give markers to a track and play it from them.

1. Press the ▷ MARK key at a position you want to mark during playback (or pause).

The current position is marked.

2. Press the F1 key to go back to the previous marker. Press it repeatedly to go back further.

Press the F2 key to go to the next marker.

- The markers are named "A, B, C,..." from the older. You can use up to 26 markers from A to Z.
- "■" is indicated on the playback position display bar to show the position of a marker. The name of the previous

nearest marker is indicated on the right side of the track number.

- Press the **▷ MARK** key while pressing and holding the **LOOP** key to delete the marker whose name is currently indicated.

Repeat playback





You can play a track repeatedly.

Press the **LOOP** key. “” appears and the current track is played back repeatedly.

To stop the repeat playback, press the **LOOP** key.

Loop playback (I-O LOOP)

With this function, you can continuously repeat the playback of a selection that you make (loop playback).

1. Press the **IN** key during playback to set the point when you want to start loop playback. The current position is set as the **IN** point.
2. Press the **OUT** key at the point when you want loop playback to stop. The current position is set as the **OUT** point, and loop playback begins between the **IN** and **OUT** points.
 - The current positions of the **IN** and **OUT** points are shown by the  and  icons that appear below the playback position display bar in the lower part of the Home screen. During loop playback the  indicator also appears.
 - Pressing the  key during loop playback slides the start point of the loop forward to its end point, keeping the time length of the loop.
Pressing the  key during loop playback slides the end point of the loop back to its start point, keeping the time length of the loop.
 - Press **IN** key or **OUT** key while pressing and holding the **LOOP** key to clear the start point or end point, respectively.

NOTE

- When the **OUT** point is not set, the part from the **IN** point to the end of the track is played back repeatedly.
- When the **IN** point is not set, from the beginning of the track to the **OUT** point is played back repeatedly.
- When the **IN** and **OUT** points is not set, the whole track is played back repeatedly.

To cancel the Loop playback, press the **LOOP** key. The **IN** point and the **OUT** point remain and the loop playback of the section starts again by pressing the **LOOP** key again.

Adjusting the volume

Use the **VOLUME** knob to adjust the output volume of the built-in speaker/**PHONES** jack/**LINE OUT** jack. The volume indicator on the front panel lights during the adjustment.



8-Recording

Recording environment

The two pairs of built-in stereo microphones on the front and rear enable you to record 360° sound. You can also record sound using external equipment connected to the **LINE IN** jack or the **EXT MIC A/B (L/R)** jacks.

Selecting the input

Follow these procedures to select the input.

NOTE

The signals from the selected input are recorded when recording.

1. Press the **INPUT** key to open the **INPUT** screen.

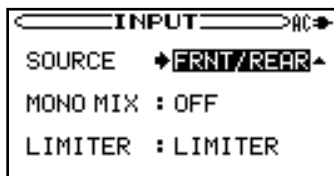

2. Press the **CURSOR** [▲/▼] key to select the **SOURCE**.

3. Turn the **DATA** wheel to select the input you want.

• **FRNT/REAR:**

Select this when you want to record the sound all around the unit.

• **FRNT/LINE:**

Select this when you want to record the sound in front of the unit or that through the **LINE IN** jack. You can also mix them up.

• **EXT/REAR:**

Select this when you want to record the sound from external microphones or that behind the unit. You can also mix them up.

• **EXT/LINE:**

Select this when you want to record the sound from the external microphones or that through the **LINE IN** jack. You can also mix them up.

CAUTION

You do not have to take care of howling as sound from microphones does not come out of the built-in speakers. Use headphones or output from the **LINE OUT** jack to monitor the sound.

Adjusting the input settings

You can adjust the input settings on the **INPUT** screen. Slide the **AUTO/LIMITER** switch on the left side to **ON** to set the **LIMITER** setting effective.

• **MONO MIX**

The signals of the left and right channels are mixed into a monaural signal. Select “**ON**” when using one monaural microphone only.

• **LIMITER**

Use this to select the function activated when the **AUTO/LIMITER** switch is “**ON**”.

• **LIMITER**

The input gain changes automatically according to the input signal level to prevent distortion caused by excessively loud sound.

• **AGC HIGH/AGC LOW**

The input gain changes automatically according to the input signal level to keep the input signal in a certain level. Useful when recording conversations such as in meetings and conferences.

Select **AGC HIGH** when input level is weak, and **AGC LOW** when strong.

NOTE

When recording live performances and in other situations where unexpected loud sounds might occur, set this function to **LIMITER** to prevent input clipping and allow recording without distortion.

CAUTION

• The input signal level may largely differ depending on the type of the external microphone you use. Generally, the level is higher when using a condenser microphone and lower when using a dynamic microphone. Especially, you may not get enough signal strength when using a low-sensitive dynamic microphone.

• The input level adjustment using the **FRONT MIC/EXT MIC** and **REAR MIC/LINE** knobs is ineffective when using **AGC**.

Volume balance adjustment

You can adjust the volume levels of microphones and volume balance of playback signal on the **BALANCE** screen.

Adjusting the balance of microphones

You can adjust the **L/R** balance of the microphone input. Use this to adjust the volume balance of the left and right channels when using two external microphones.

1. Press the **BALANCE** key to open the **BALANCE** screen.



2. Press the **CURSOR** [▲/▼] key to select the **MIC L/R** item.

3. Turn the **DATA** wheel to adjust the balance.

The adjustable range is **L50 - C (center) - R50**.

NOTE

Pressing the **F1** key returns the balance to **C** immediately.

Adjusting the level of playback signal

You can adjust the balance between the playback volume of media and that of input. Use this to adjust the balance between the playback volume and instrument volume when overdubbing.

1. Press the BALANCE key to open the BALANCE screen.



2. Press the CURSOR [▲/▼] key to select the MIX BALANCE item.
3. Use the DATA wheel to adjust the playback volume of the media.

Set the volume between 10 and 100. The maximum playback volume at 100.

NOTE

Press the F2 key to set MIX BALANCE to 100 immediately. Use it while playback stops or after turning down the output volume.

Ordinary recording

Set the recording media and change the target media (source) to it before recording.

NOTE

- It is recommended to select an SD card as the recording media when recording the sound through the built-in microphones as they may pick up rotation noise of during recording on a disc.
- You can record up to 99 tracks on a disc.
- You can select a file format when recording on an SD card (→ page 45 "Long time recording").
- The maximum sum total of files and folders you can make on an SD card is 999. You can make up to 99 files in a folder within the limit.

1. Press the REC/READY [●] key.

The Record screen appears and the unit becomes on standby for recording.

The REC/READY [●] key flashes.

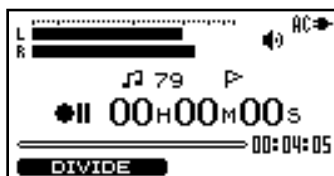

2. Adjust the input level by turning the FRONT MIC/EXT MIC knob and the REAR MIC/LINE knob.

The input level is indicated on the L/R meter. The indicators upper left of the knobs light when the input is too loud.



Check the L/R meter and adjust the level so that the signal peak does not go over the second scale from the right.

3. Press the REC/READY [●] key to start recording. The REC/READY [●] key lights during recording.
4. Recording stops when pressing the STOP key during recording or recording-on-standby. The REC/READY [●] key goes off.
 - Pressing the REC/READY [●] key during recording returns the unit on standby for recording. The REC/READY [●] key flashes during recording-on-standby. Recording on a new file starts as you press the REC/READY [●] key again. The REC/READY [●] key lights steadily.

NOTE

Press the F1 key during recording to continue the recording on a new track without stopping.

Overdubbing

You can mix up the CD/SD card playback sound and that from other sources such as your singing or playing an instrument and record the mixed-up sound on the SD card. Normally, the playback sound is recorded through microphones along with your playing or singing sound. The playback sound can be recorded directly in the unit by using the DIRECT MIX mode.

NOTE

Be sure to insert an SD card before overdubbing as the recording media for overdubbing is fixed to an SD card regardless of playback media.

Preparation for overdubbing

Follow these procedures to prepare for overdubbing. Set the file type to WAV.

CAUTION

Only WAV files can be created by overdubbing.

1. Press the MENU key to open the MENU screen.
2. Press the CURSOR [▲/▼] key to select REC SETTING (highlighted in inverse) and press the ENTER key.
3. Press the CURSOR [▲/▼] key to select FILE TYPE.
4. Use the DATA wheel to select WAV.



5. Press HOME to return to the Home screen.

8-Recording

Adjust the balance between the playback volume of media and that of input to record.

1. Select the playback media and press the ◀◀/▶▶ keys to select a playback track.
2. Press the PLAY/READY [▶/II] key to start playback, and check the volume balance between the playback and the input sounds.
3. Use the BALANCE keys as necessary to adjust the balance by increasing or decreasing the playback signal volume. (→ page 38 “Volume balance adjustment”)

TIP

When overdubbing the sound of an electric instrument through the LINE IN jack, activate the DIRECT MIX mode described later. However, DIRECT MIX mode is automatically activated when you use the headphones for monitoring.

Overdub recording

Finish the settings above before starting overdub recording: Select the input and playback source, finish input level adjustment, and set the recording file type to WAV.

1. Slide the SPEAKER switch to ON and disconnect the headphones.
2. Press the OVERDUB key to make the unit on standby for overdubbing. You can start overdubbing during playback.

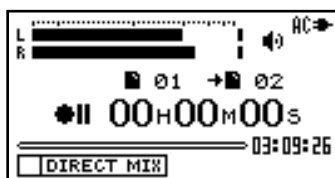

NOTE

- On the overdub screen, the playback file number and the recording file number are indicated instead of the recording file number and the marker name on the Recording screen, respectively.
- Press the PLAY/READY [▶/II] key during recording-on-standby, you can start playback without recording. You can also fast-forward/reverse by pressing and holding the ◀◀/▶▶ key.

3. Press the REC/READY [●] key to start overdubbing. The REC/READY [●] key lights during recording.
 4. Recording stops when pressing the STOP key during recording or recording-on-standby. The REC/READY [●] key goes off.
- Pressing the REC/READY [●] key during recording returns the unit on standby for recording. The REC/READY [●] key flashes during recording-on-standby. Recording on a new file starts as you press the REC/READY [●] key again. The REC/READY [●] key stops flashing.

NOTE

When using external microphones, set them at the same distance from the unit and the instrument's part that sound comes out.

Overdubbing in higher sound quality (DIRECT MIX)

In ordinary overdubbing, both the playback sound of a disc or SD card and your playing sound are recorded through the microphones.

In the DIRECT MIX mode, the playback sound is recorded directly in the unit and you can mix sounds in higher quality.

However, headphones are required for monitoring to prevent the microphones from picking up the playback sound.

The DIRECT MIX mode is automatically activated as headphones are connected.

When you overdub the sound of an electric instrument through the LINE IN jack, you can activate the DIRECT MIX mode manually and overdub sounds in higher quality without using headphones for monitoring.

Follow the steps below to activate the DIRECT MIX mode manually.

1. Press the OVERDUB key to make the unit on standby for overdubbing.
2. Press the F1 key to activate the DIRECT MIX mode.



Execute the same procedure as ordinary overdubbing after pressing the F1 key.

9—For practicing musical instruments

Using the Tuner

The BB-1000CD has a built-in tuner. By using a mic to input the sound of an instrument, you can use the tuning meter on the display to tune that instrument accurately. In addition, you can output a tuner sound to, for example, tune multiple instruments simultaneously.



Preparation

1. Press the TUNER key to open the Tuner screen.
The screen of chromatic tuner mode appears.



2. Press the F1 key to select a tuner mode.

Each time you press the key, the mode changes between the chromatic tuner mode and the oscillator mode.

-  Changes to the oscillator mode
-  Changes to the chromatic tuner mode

3. Use the CALIB item to set the frequency of A above middle C (A4) between 435 Hz and 445 Hz.

The set value appears in the lower right part of the screen. This setting affects both tuner modes.

Use of the two tuner modes is explained below.

Chromatic tuner mode

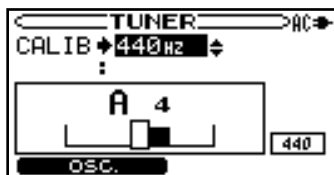

This is the default mode. Use the tuning meter on the BB-1000CD's screen to tune your instrument. The tuning meter and input signal pitch appear on the screen. ("—" appears when no sound is input or the input sound is out of the measurable range.)

1. The input is automatically changed to the left microphone on the front panel and the input setting is changed to AGC.
2. Input the sound of the instrument you are tuning through the microphone. The name of the closest pitch appears in the upper part of the meter.

3. Tune the instrument until the desired pitch is shown and the center of the meter is highlighted. A bar appears to the left if the tuning is too low and a bar appears to the right if it is too high. The longer the bar is the more out of tune the instrument is.

TIP

You can check the difference of the pitch also at the volume/playback/recording indicator.

The center LED lights up in green when the tuning is fine.

The center LED lights up in red and green LEDs show the degree of pitch difference when out of tune.

Oscillator mode

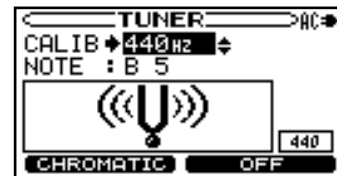

The built-in oscillator can output a sine wave of a pitch in the three octaves between C3 and B5 through the built-in speakers.

In addition to the CALIB item described above, you can change oscillation pitch on the NOTE item.

NOTE

Set the output pitch (C3–B5).

Press the F2 key to turn the oscillator sound ON/OFF.

Using the Metronome

The BB-1000CD has a built-in metronome that outputs its sound. The volume/playback/recording indicator lights up along with its time.

Setting the metronome

To use the metronome, press the METRONOME key to open the METRONOME screen.

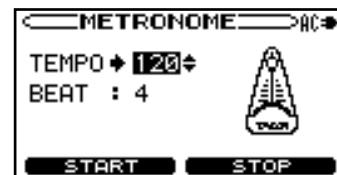

You can set the following items on the METRONOME screen.

TEMPO

Set the speed to a value between 20 and 250 beats per minute (BPM).

BEAT

Set the accent frequency between 0 and 9. There is no accent when set to 0. For example, set this to 4 if you want 4/4 time.

9—For practicing musical instruments

Starting and stopping the metronome

On the metronome screen, press the F1/F2 key to start/stop the metronome.

NOTE

- The indicator on the front panel lights along with the time of the metronome.
- When using the metronome, you cannot return to the Home screen.

Practicing with CD/SD playback

Not only can you use the unit to change the tempo of track playback, you can even do this without changing the pitch. You can also change the playback pitch of a track without changing the tempo.

Furthermore, you can also reduce (cancel) the sound of a voice or solo instrument on a track. You can use these playback control functions effectively to practice and learn parts.

Changing the playback key

You can change the key (pitch) of playback sound without changing playback speed by using the **KEY** knob and the **FINE PITCH** knob.

Use the **KEY** knob to adjust the pitch up or down by semitone (b6 - #6).

Use the **FINE PITCH** knob to adjust the pitch finely by a cent (1/100 of a semitone). The adjustable range is **-50 - +50**.

Changing the playback speed

Use the **SPEED** knob to control the playback speed.

Since the speed adjustment range is **-50%** to **+16%** (in 1% increments), the slowest speed setting is half the original speed.

Reducing sound of a certain location (PART CANCEL)

You can select a certain position and reduce the sound volume from the position. For example, selecting C (center) on a commercially available audio CD reduces vocal sound (part cancel function).

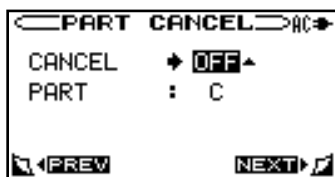

NOTE

The effect differs depending on the characteristic of the sound source.

1. Press the **MENU** key to open the **MENU** screen.

2. Press the **CURSOR** [**▲**/**▼**] key to select the **PART CANCEL** item and press the **ENTER** key.

3. Turn the **DATA** wheel to select an item and adjust it.

The adjustable items are the two below:

CANCEL (the factory setting is OFF)

Set the **CANCEL** item to **ON** to turn the part cancel function **ON**.

Depending on the music, the part cancel function may not reduce the recorded vocal or solo instrument sound sufficiently. If this is the case, changing the **PART** setting might make the reduction more effective. Listen to the music as you adjust the settings to achieve the best effect.

PART (the factory setting is C)

Adjust this setting to match the stereo position of the sound that you want to reduce (**L10-C-R10**).

Practicing a certain phrase repeatedly

You can continuously repeat the playback of a selection that you make (loop playback).

(→ page 37 “Loop playback (I-O LOOP)”)

Recording the practice with CD/SD

This unit can mix and record its playback track and the sounds from microphones and the **LINE IN** jack.

(→ page 39 “Overdubbing” on “8-Recording”)

10—Other useful functions

Backing up audio files

You can copy tracks on a CD into an SD card as audio files and write files on an SD card on to a disc on the COPY screen.

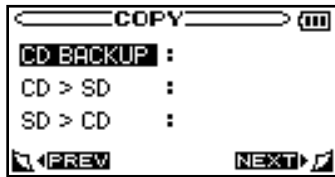

Copying a CD onto an SD card

You can copy tracks on a CD onto an SD card. The tracks are copied into the folder currently used. If you want to copy them into another folder, select it on the BROWSE screen before copying (→ page 48 “Browsing an SD card”).

1. Press the MENU key to open the MENU screen.
2. Press the CURSOR [▲/▼] key to select COPY and press the ENTER key.
3. Press the CURSOR [▲/▼] key to select CD>SD and press the ENTER key.
4. Press the CURSOR [▲/▼] key to select a file format to record onto the SD card and press the F2 key.

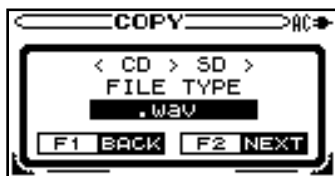

NOTE

You can select a format from WAV, MP3 (low), MP3 (normal), and MP3 (high). The recording time is longer in the following order: WAV < MP3 (high) < MP3 (normal) < MP3 (low). The longer the recording time is, the worse the sound quality becomes.

5. Press the CURSOR [▲/▼] key to select the target track and press the ENTER key.

The check mark is indicated by the selected track.



NOTE

Select the track again and press the ENTER key to uncheck it.

6. Repeat step 5 until all the target tracks are checked and press the F2 key.

The confirmation screen appears.



7. Press the F2 key to start copying.

The COPY screen appears after copying is finished.

Writing files on an SD card onto a disc

1. Press the MENU key to open the MENU screen.
2. Press the CURSOR [▲/▼] key to select COPY and press the ENTER key.
3. Press the CURSOR [▲/▼] key to select SD>CD and press ENTER.

The TRACK LIST screen appears and show the files recorded on the SD card.

4. Press the CURSOR [▲/▼] key to select the target file and press the ENTER key.

The check mark is indicated by the selected file.



NOTE

Select the file again and press the ENTER key to uncheck it.

5. Repeat step 4 until all the target files are checked and press the F2 key.
6. Press the CURSOR [▲/▼] key to select a file you want to change the order of and press the ENTER key.

The selected file is highlighted and you can change its order in the disc.



7. Press the CURSOR [▲/▼] key to move the file and press the ENTER key.



8. Repeat step 7 until you finish changing the order of files and press the F2 key.

10–Other useful functions



9. Load a blank disc and press the F2 key.

The selected files are written onto the disc. If you want to make another copy, load a new blank disc following the messages on the screen after finishing and press the F2 key. Press the F1 key to finish and return to the COPY screen.

Backing up an audio CD

You can create a backup disc of an audio CD.

NOTE

An SD card which has free space enough to copy the contents of the CD is required for duplicating it.

1. Press the MENU key to open the MENU screen.
2. Press the CURSOR [▲/▼] key to select COPY and press the ENTER key.
3. Press the CURSOR [▲/▼] key to select CD BACKUP and press the ENTER key.



4. Load the SD card and the target CD and press the F2 key. The temporary copy to the SD card starts.

NOTE

A caution appears when the capacity is not enough. Insert an SD card with enough space and press the F2 key to proceed to the next step.



The CD is automatically ejected as the unit finish copying it onto the SD card and the message to prompt to insert a blank disc appears.



5. Load a blank disc and press the F2 key.

The duplication starts. The disc is automatically ejected after finishing duplication. If you want to make another copy, load a new blank disc and press the F2 key. Press the F1 key to finish and return to the COPY screen.



Changing recording settings

You can change the various settings relating to recording on the REC SETTING screen.



Auto recording

You can set the unit to start/stop recording automatically from recording-on-standby depending on the status of input signals. It is convenient when you need to start recording from the position far from the unit.

1. Press the MENU key to open the MENU screen.
2. Press the CURSOR [▲/▼] key to select REC SETTING and press the ENTER key.
3. Adjust the four settings below.

AUTO LEVEL:

Set the signal level at which recording starts/stops automatically.

START:

While set to ON, recording automatically starts as the unit is on-standby for recording and detects an input signal whose level is higher than that set on AUTO LEVEL.

STOP:

Set the time from detecting the input signal level lower than that set on AUTO LEVEL to stopping recording to on-standby.

DIVIDE:

When setting this to ON, the recording file is divided as the input signal level becomes higher than that set on AUTO LEVEL again after 2 second or more declining signal level.

10–Other useful functions

4. Press the HOME key to return to the Home screen.

TIP

- You can skip unnecessary silent moments during recording by setting START and STOP above. If you want to divide recording files at each silence but require no skipping silence, activate DIVIDE only.
- By the combination of START, STOP and DIVIDE, you can set the unit to record sounds skipping silence longer than 5 seconds (time set on STOP) and dividing files at each silence, for example.

Long time recording

You can change the recording file format to make the recording time longer.

1. Press the MENU key to open the MENU screen.
2. Press the CURSOR [▲/▼] key to select REC SETTING and press the ENTER key.
3. Press the CURSOR [▲/▼] key to select FILE TYPE.

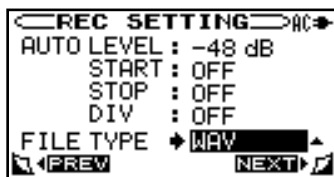

4. Turn the DATA wheel to select a file format and press the ENTER.

NOTE

You can select a format from WAV, MP3 (low), MP3 (normal), and MP3 (high). The recording time is longer in the following order: MP3 (low)>MP3 (normal)>MP3 (high)>WAV. The longer the recording time is, the worse the sound quality becomes.

CAUTION

Select WAV when you use overdubbing or you want to edit the file using the DIVIDE function on the EDIT screen after recording. (→ page 39 “Overdubbing” on “8-Recording”)

5. Press the HOME key to return to the Home screen.

About the recording time

The following tables show the recording times for each recording format and media capacity.

Recording format	CD / capacity	
	650MB	700MB
CD-DA 16 Bit, 44.1 kHz	1 hour 14 minutes	1 hour 20 minutes

Recording format (FILE TYPE)		SD/SDHC card capacity				
		1GB	2GB	4GB	8GB	16GB
WAV 16 Bit, 44.1 kHz		1 hour 39 minutes	3 hours 18 minutes	6 hours 36 minutes	13 hours 12 minutes	26 hours 24 minutes
MP3	Low (44.1 kHz, 64 kbps)	35 hours 50 minutes	71 hours 40 minutes	143 hours 20 minutes	286 hours 40 minutes	573 hours 20 minutes
	Normal (44.1 kHz, 128 kbps)	17 hours 55 minutes	35 hours 50 minutes	71 hours 40 minutes	143 hours 20 minutes	286 hours 40 minutes
	High (44.1 kHz, 192 kbps)	11 hours 57 minutes	23 hours 54 minutes	47 hours 48 minutes	95 hours 36 minutes	191 hours 12 minutes

- The recording times on the table above is approximate ones. Actual recording time may vary depending on the SD/SDHC card you use.
- The recording times on the table above show total time recordable on an SD/SDHC card, not the maximum continuous recording time.
- You cannot record continuously for more than 23 hours and 59 minutes. The maximum size of a single recording file is 2 GB.

10—Other useful functions

Editing a file

You can edit files on an SD card on the **EDIT** screen. Change the recording/playback media to SD and insert an SD card before editing.

NOTE

You cannot edit files on a disc.

1. Press the **MENU** key to open the **MENU** screen.
2. Press the **CURSOR** [**▲/▼/◀/▶**] key to select **EDIT** and press the **ENTER** key.

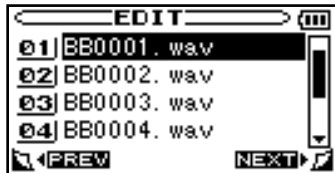

The contents of the folder that contains the file that was selected on the Home screen before the **EDIT** screen was opened appears on the display.

3. Press the **CURSOR** [**▲/▼**] key to select a file you want to edit and press the **ENTER** key.

A pop-up window appears as below.



4. Select an operation you want to apply to the selected file.

PLAY

Return to the Home screen and playback the selected file.

DIVIDE

Select this to divide the file.

The screen changes to the Home screen and playback of the selected file starts. Press the **ENTER** key at the position you want to divide the file at. The confirmation message appears and the unit plays back 2 seconds from the selected position repeatedly. Press the **F1** key to divide it at the position. To cancel, press the **F2** key.



Close the confirmation message and press the **MENU** key to return to the **EDIT** screen.

MOVE

Select this to change the playback order of files. Press the **CURSOR** [**▲/▼**] key to move the selected file and press the **ENTER** key at the position you want.

DELETE

Select this to delete the file. The confirmation message appears. Press the **F1** key to delete the file. To cancel, press the **F2** key.

CANCEL

Select this to cancel the operation to the file.

- Press the **PLAY/READY** [**▶/||**] key to return to the Home screen and start playback of the file currently selected.

NOTE

*You can open the **EDIT** screen directly by pressing the **ENTER** key during playback/pause. The file currently played back is selected when the screen is opened.*

*Pressing the **ENTER** key without changing the file selection and selecting **DIVIDE** will start 2-second repeat playback at the position played back or paused and the confirmation message of **DIVIDE** will appear.*

11-Managing recording media

You can finalize/unfinalize a disc, delete tracks on a CD-RW, browse and format an SD card on the MEDIA screen.



CAUTION

You cannot handle a disc on the MEDIA screen when the unit is running by battery power. Supply the power through the AC adapter.

Finalizing a disc

To playback a disc recorded on the unit on another device, you need to finalize it manually. Change the source to CD and load a disc to finalize before starting the operations below.

1. Press the MENU key to open the MENU screen.
2. Press the CURSOR [▲/▼] key to select MEDIA and press the ENTER key.
3. Press the CURSOR [▲/▼] key to select FINALIZE and press the ENTER key.

The MEDIA CD screen appears.

The confirmation message appears



4. Press the F1 key.

Finalization starts.

The MEDIA CD screen appears after finishing finalization.

NOTE

A finalization confirmation message appears when ejecting a disc not finalized yet. Press the F1 key to finalize it. Press the F2 key to eject it without finalization.



Unfinalizing a CD-RW

You can record additional files on a finalized CD-RW after unfinalizing it using UNFINALIZE.

Change the source to CD and load a CD-RW to unfinalize before starting the operations below (→ page 31 “Loading a disc”).

1. Press the MENU key to open the MENU screen.
2. Press the CURSOR [▲/▼] key to select MEDIA and press the ENTER key.
3. Press the CURSOR [▲/▼] key to select UNFINALIZE and press the ENTER key.

The MEDIA CD screen appears.

The confirmation message appears



4. Press the F1 key.

Unfinalization starts.

The MEDIA CD screen appears after finishing unfinalization.

Deleting tracks on a CD-RW

You can delete tracks on a CD-RW. All tracks or the last track is deletable.

Change the recording/playback to CD and load a CD-RW containing tracks to delete before starting the operations below.

1. Press the MENU key to open the MENU screen.
2. Press the CURSOR [▲/▼] key to select MEDIA and press the ENTER key.

The MEDIA CD screen appears.

11—Managing recording media

3. Press the **CURSOR** [▲/▼] key to select **ERASE** and press the **ENTER** key.



4. Use the **DATA** wheel to select **LAST TRACK** or **ALL TRACK** and press the **F1** key.

The selected tracks are deleted.

Press **F2** key to cancel the operation.

Browsing an SD card

You can see folders and audio files on an SD card and select a folder to playback on the **BROWSE** screen.

To open to the **BROWSE** screen

Change the source to SD and insert an SD card before starting the operations below.

1. Press the **MENU** key to open the **MENU** screen.
2. Press the **CURSOR** [▲/▼] key to select **MEDIA** and press the **ENTER** key.
3. Press the **CURSOR** [▲/▼] key to select **BROWSE** and press the **ENTER** key.

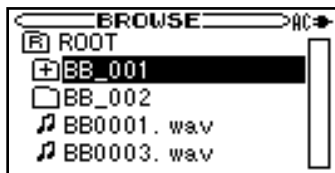

The contents of the folder that contains the file that was selected on the Home screen before the **BROWSE** screen was opened appears on the display.

NOTE

- The maximum sum total of files and folders on an SD card the unit can recognize is 999. A folder can contain up to 99 files within the limit.
- The file order listed on the **BROWSE** screen is different from the actual playback order. Open the **EDIT** screen to check the playback order (→ page 46 "Editing a file").
- You can change the playback order of files using the **MOVE** function (→ page 46 "Editing a file").

Screen navigation

On the **BROWSE** screen, folders and music files appear in a hierarchical structure much like they would appear on a computer. On the BB-1000CD, folders can only be used to two levels.

- Press the **CURSOR** [▲/▼] key to select files and folders.
- When a folder is selected, press the **CURSOR** [▶] key to show the contents of that folder.
- When a file or folder is selected, press the **CURSOR** [◀] key to exit the currently open folder and go to a higher level in the folder structure.

Icons on the **BROWSE** screen

The meanings of icons that appear on the **BROWSE** screen are as follows.

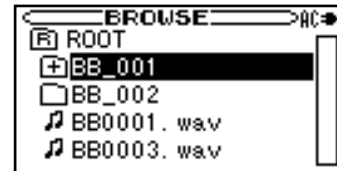

📁 **ROOT folder**

The **ROOT** Folder is the highest (root) level folder in the hierarchy shown on the **BROWSE** screen.

🎵 **Audio file**

This icon appears before the names of music files.

⊕ **Plus folder**

This icon shows folders that contain subfolders.

□ **Plain folder**

This icon shows folders that do not contain subfolders.

📂 **Open folder**

The contents of the folder marked with this icon currently appear on this screen.

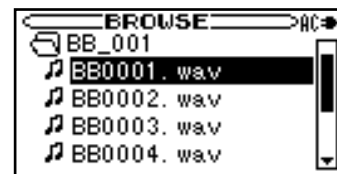

File operations

Select the desired audio file on the **BROWSE** screen and press the **ENTER** key to open the pop-up window that is shown below.



Press the **CURSOR** [▲/▼] key to select the item you want from the list to the right and press the **ENTER** key to execute it.

PLAY

Return to the Home screen and playback the selected file.

11—Managing recording media

DELETE

A message appears to confirm that you want to delete the file. Press the **F1** key to erase the file and the **F2** key to cancel the deletion operation.

CANCEL

No operation is conducted and the selected file is left as is.

- Press the **PLAY/READY** [▶/||] key to return to the Home screen and start playback of the file currently selected.

Folder operations

Select the desired folder on the **BROWSE** screen and press the **ENTER** key to open the pop-up window that is shown below.

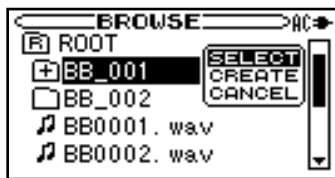

Press the **CURSOR** [▲/▼/◀/▶] key to select the item you want from the list to the right and press the **ENTER** key to execute it.

SELECT

Returns to the Home screen and selects the first file in the folder. This folder becomes the new playback area regardless of the previous playback area setting. When recording, files are created in this folder.

CREATE

A pop-up appears to confirm that you want to create a new folder. Press the **F1** key to create a new folder, or press the **F2** key to cancel the operation. You can make first level subfolders.



However, if you try to create a new folder inside a second level subfolder the message “**Layer too deep.**” appears and the folder is not made.

CANCEL

No operation is conducted and the selected folder is left as is.

Formatting an SD card

You can format an SD card when SD is selected as the source and playback or recording is stopped.

It is recommended to format an SD card on the unit when you record sound on the SD card using the unit.

Using an SD card formatted on other devices may increase the possibility of recording errors.

CAUTION

- All the folders and files recorded on an SD card are erased by formatting.
- Use the AC adapter or install new batteries when formatting an SD card. Formatting cannot be finished properly when the batteries run out during formatting.

1. Press the **MENU** key to open the **MENU** screen.

2. Press the **CURSOR** [▲/▼] key to select **MEDIA** and press the **ENTER** key.

The **MEDIA SD** screen appears.

3. Press the **CURSOR** [▲/▼] key to select **FORMAT** and press the **ENTER** key.

The confirmation message appears.



4. Press the **F1** key.

Formatting starts.

The **MEDIA SD** screen appears after finishing format.

12-Environmental settings

On the **SET UP** screen, you can change various settings according to the environmental conditions for your comfortable use of the unit.

To open the SET UP screen

1. Press the **MENU** key to open the **MENU** screen.
2. Press the **CURSOR [▲/▼]** key to select **SET UP** and press the **ENTER** key.



The following settings can be made for the items on the **SET UP** screen.

Backlight Auto OFF setting

Use **BACKLIGHT** to set the time until the backlight automatically turns OFF after the last operation when powered by the internal batteries.

Options: **OFF** (backlight always on), **5 sec** (factory setting), **10 sec**, **15 sec**, **30 sec**

Adjust the display contrast

Use **CONTRAST** to adjust the display contrast.

Options: **1 – 20** (factory setting: **8**)

Adjusting the time of FLASH BACK

Use **FLASH BACK** to adjust the time to skip back by the flash back function.

Options: **1 sec – 5 sec** (factory setting: **2 sec**)

Setting the date and time

Use **DATE/TIME** to adjust the built-in clock. (→ page 29 “Setting the date and time” on “4-Preparation”)

13–Messages

The following popup messages alert you to conditions that may arise while you are using the unit. Consult this table if you see something you do not understand.

Messages	Meaning and remedy
File not found	The audio file cannot be found or is corrupted. Check the file (using a computer).
Non-Supported	The audio file is not a supported format. Check the file format (using a computer).
Battery Empty	The battery is almost out of power. Turn off the power and replace the battery or supply the power through the AC adapter.
I/O Too Short	When using the IN or OUT key, the IN and OUT points are too close together to start loop playback. Reset the IN and OUT points and try again.
Write Timeout	Writing to the card timed out. Backup files on the card to your computer, and format the card using the unit.
Media Full	Erase unnecessary files or move them to your computer to make open space.
Max File Size	The size of a file reaches 2 GB or recording continues for 24 hours.
File Full	The total number of files in a folder is already 99 or the total number of folders and files is already 999. Erase unnecessary files or move them to your computer
No Card	No SD card is found at recording. Insert a recordable SD card and try again.
Protected Card	This appears when the card in the unit during startup is a protected card without the necessary Music Folder and other folders and files.
Battery Low	Try to record when batteries will soon run out. Replace the batteries or supply the power through the AC adapter.
No CD	No disc is found at recording. Insert a recordable disc and try again.
Not Audio CD	An incompatible disc is found at recording. Insert a recordable disc and try again.
CD is CLOSED	A finalized disc is found at recording. Insert a recordable disc or, if the disc is a finalized CD-RW, unfinalize it (→ page 47 “Unfinalizing a CD-RW”) and try again.
Format is MP3	The recording format is set to MP3 at overdubbing. Change the format to WAV at FILE TYPE on REC SETTING (→ page 45 “Long time recording”).
No PB File	No playback file/track is found at overdubbing. If the playback media is CD, insert an audio CD containing tracks and try again. If the playback media is an SD card, add an audio file to it and try again.
Layer too Deep	You cannot make any folder at the current hierarchy. Make one at a hierarchy above.
File Protected	This appears when trying to delete or divide a read-only file. You cannot delete or divide the file on the unit.
File Num Full	Recording on to an SD card is stopped as the unit tried to make a new recording file automatically at reaching the limit of one single recording file but cannot because 99 files had already been made in the recording.
Over 74 minute	The total time of selected files is more than 74 minutes when copying files on an SD card on to a disc. Use a disc with 80-minute capacity or deselect some files.
Over 80 minute	The total time of selected files is more than 80 minutes when copying files on an SD cards on to a disc. You cannot copy all the selected files even on 80-minute disc. Deselect some files.
Over track.	More than 99 files/tracks are selected when copying files/tracks. You cannot select no more files/tracks. Deselect some files/tracks to select others.
Cannot Execute	This appears when trying to execute the operations below: <ul style="list-style-type: none"> • Try to execute ERASE on a disc other than audio CD or CD-RW. • Try to execute FINALIZE on a disc other than audio CD or CD-R/RW. • Try to execute UNFINALIZE on a disc other than audio CD or CD-RW.
Finalized Disc	You tried to execute FINALIZE on a finalized disc. You do not have to finalize it.
Not Finalized	You tried to execute UNFINALIZE on an unfinalized disc. You do not have to unfinalize it.

13–Messages

Messages	Meaning and remedy
Execute Failed	The unit failed to execute FINALIZE/UNFINALIZE/ERASE for some reasons. Check dirt or scratch on the media.
Cannot DIVIDE less than 2sec	This appears when you try to divide a WAV file whose length is 2 seconds or less. You cannot execute DIVIDE on files whose length are 2 seconds or shorter.
MBR Error Init CARD	There is a problem with the Master Boot Record. The card is not formatted properly or the formatting is broken. When “Are you Sure?” appears, press the ENTER key to format the entire card in FAT format.
Format Error Format CARD	The FAT formatting of the card is abnormal or broken.
Invalid Card Change Card	This appears when SD-card errors occur at turning on the unit.
Card Error	There was some sort of error with the card. Turn off the power and replace the card with a working card.
Disc Error	The unit failed to writing data on a disc. Check dirt and scratch on the disc.
CD Drive Error	If any of these errors occur, turn the BB-1000CD power OFF and restart the unit. Disconnect the AC adapter or uninstall the batteries if you cannot turn the power off. If the error message continues to appear, contact a TEAC Repair Center
Not Continued	
File Error	
Player Error	
Device Error	
Writing Failed	
Sys Rom Err	
System Err 50	
System Err 1	
System Err 2	
System Err 3	
System Err 4	
System Err 5	
System Err 6	
System Err 7	
System Err 8	
System Err 9	

If you experience any problems with the unit, please take a moment to look through this chart and see if you can solve the problem yourself before you call your dealer or a TEAC service center.

No power

- Check the connection to the AC power source.
- Check the polarity of the batteries.

Remote control doesn't work.

- Check the battery. Change it if exhausted.

No sound

- Disconnect headphones.
- Slide the **SPEAKER** switch to **ON**.
- Check the connection to the monitor system.
- Check the volume level.

The sound to record hears distorted.

- The setting of **FRONT MIC/EXT MIC** knob or **REAR MIC/LINE** knob is too high.
- The input signal level is too high.

The sound is noisy.

- Check the connection of cables.

Will not play a CD.

- If the disc is dirty, clean the surface of the disc.

15–Specifications

Specifications

CD recorder

Media type

CD-DA

CD playback specifications

Sampling frequency: 44.1 kHz

Quantization bit rate: 16 bit

Channel: 2 channels

Audio input and output

LINE INPUT(L/R) [UNBALANCED]

Analog, unbalanced

Jack: RCA pin

Maximum input level: +6 dBV

Normal input level: -10 dBV

Minimum input level: -22 dBV

Input impedance: 20 k Ω

EXT MIC A/B(L/R) [BALANCED]

Analog, balanced

Jack: XLR-3-32 correspondent

(1=ground, 2=hot, 3=cold)

Maximum input level: +3 dBu

Normal input level: -13 dBu

Minimum input level: -55 dBu

Input impedance: 2.4 k Ω

Build-in microphone

Front: Omnidirectional L/R

Rear: Omnidirectional L/R

LINE OUTPUT(L/R) [UNBALANCED]

Analog, unbalanced

Jack: RCA pin

Normal output level: -10 dBV

Maximum output level: +6 dBV

Output impedance: 200 Ω

PHONES

Headphone output

Jack: Stereo mini jack (3.5 mm dia.)

Rated output: more than 30 mW + 30 mW

(THD+N less than 1.0%, 32 Ω load)

SPEAKERS

3 inch x 2

AMPLIFIERS

5 W + 5 W Digital amplifiers

Audio performance

Frequency response

20-20 kHz (\pm 1 dB)

Distortion (THD+N)

0.05% (1 kHz LPF 20 kHz)

Signal to noise ratio

85 dB (1 kHz, LPF 20 kHz A-Weighted)

General

Recording media:

SD card (64 MB to 2 GB) and SDHC card (4 GB to 32 GB)

File system

FAT partition: FAT16/32

Controllable range of the remote control:

Head-on to the sensor: 7 m

15° left/right from the sensor: 4 m

Battery life (Continuous operation):

About 1.5 hours: (CD playback, Speaker output mode)

About 2.5 hours:

(SD record/playback, Speaker output mode)

About 4.5 hours:

(SD record/playback, headphone output mode)

Operating temperature:

5 to 35°C

Power:

AC adapter input: AC100 - 240V, 50 - 60 Hz

AC adapter output: 12V DC

AC adapter output current: 2.5 A

Power consumption:

30 W (when playing back CD, Line In: +6 dBV input,

Maximum speaker output)

Dimensions (W x H x D):

380 x 204.7 x 107 mm

Weight:

3.4 kg

* Illustrations may differ slightly from production models.

* Design and specifications are subject to change without notice.

Dimensions

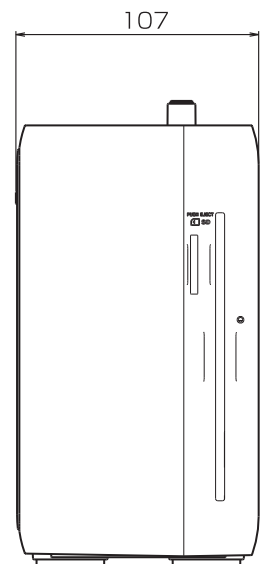
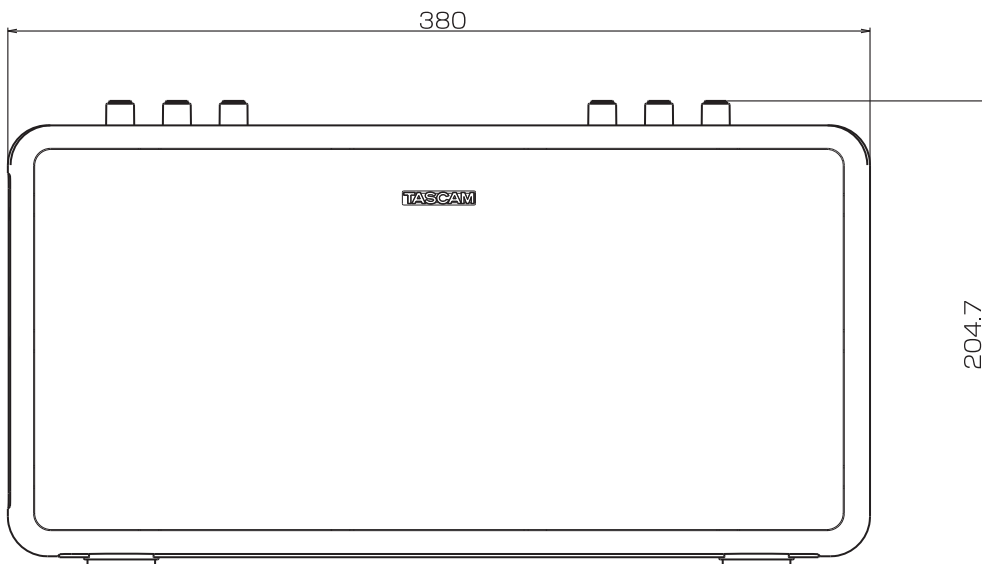
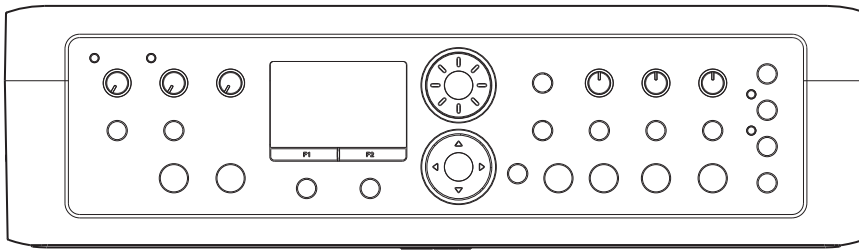

TASCAM[®]
TEAC PROFESSIONAL

BB-1000CD

TEAC CORPORATION

Phone: +81-42-356-9143
1-47 Ochiai, Tama-shi, Tokyo 206-8530 Japan

www.tascam.jp

TEAC AMERICA, INC.

Phone: +1-323-726-0303
7733 Telegraph Road, Montebello, California 90640 U.S.A.

www.tascam.com

TEAC CANADA LTD.

Phone: +1905-890-8008 Facsimile: +1905-890-9888
5939 Wallace Street, Mississauga, Ontario L4Z 1Z8, Canada

www.tascam.com

TEAC MEXICO, S.A. de C.V.

Phone: +52-55-5010-6000
Río Churubusco 364, Colonia Del Carmen, Delegación Coyoacán, CP 04100, México DF, México

www.teacmexico.net

TEAC UK LIMITED

Phone: +44-8451-302511
Suites 19 & 20, Building 6, Croxley Green Business Park, Hatters Lane, Watford, Hertfordshire. WD18 8TE, U.K.

www.tascam.co.uk

TEAC EUROPE GmbH

Phone: +49-611-71580
Bahnstrasse 12, 65205 Wiesbaden-Erbenheim, Germany

www.tascam.de